

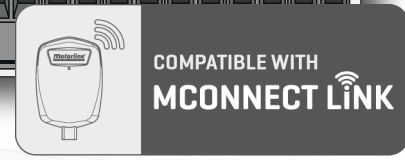

MC52

USER/INSTALLER MANUAL

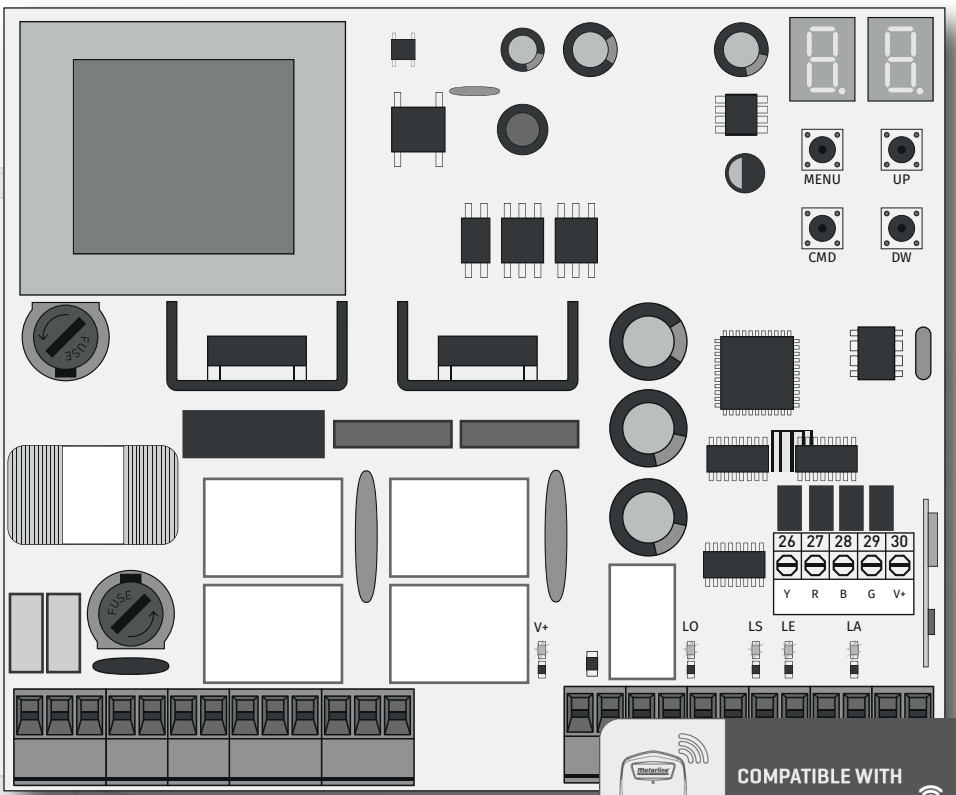
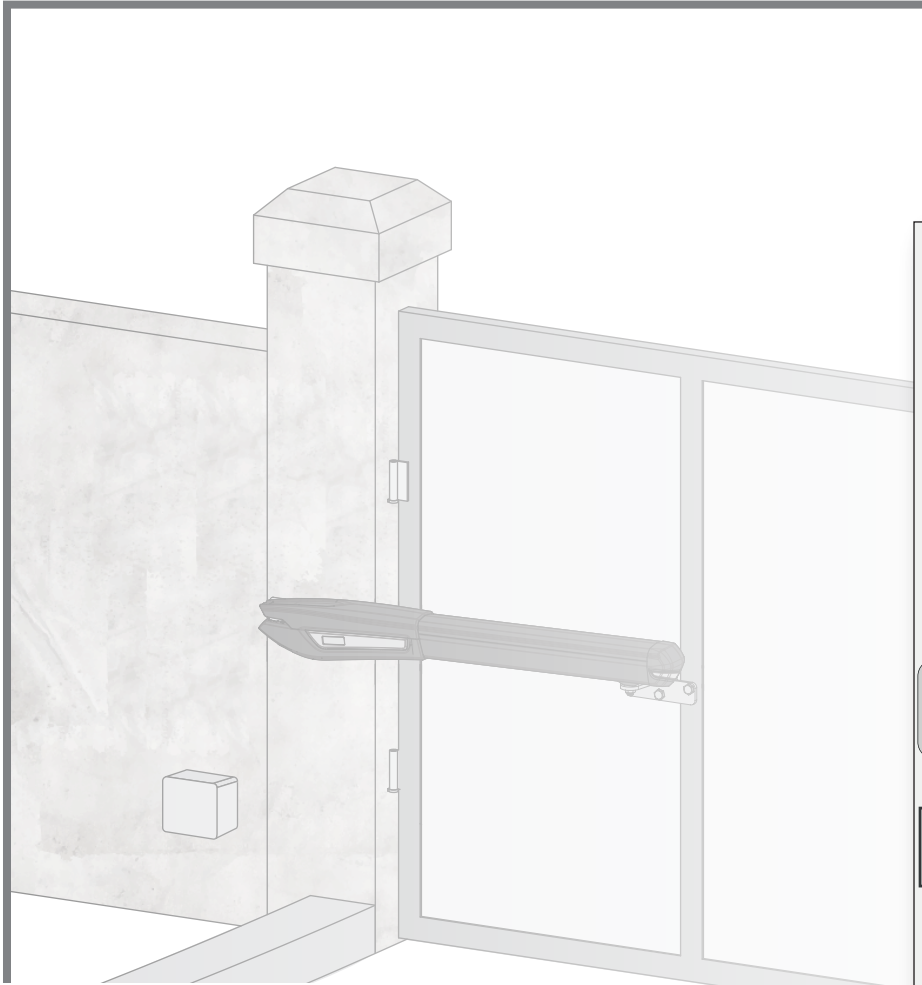

motorline[®]







PROFESSIONAL

00. CONTENT

INDEX

01. SAFETY INSTRUCTIONS	1B
02. THE CONTROL BOARD	
TECHNICAL SPECIFICATIONS	4A
LEDs	4A
CONNECTORS	4B
03. INSTALLATION	
INSTALLATION MAP	5
INSTALLATION MAP - SAFETY SELF-TEST	6
MCONNECT LINK INSTALLATION (OPTIONAL)	7A
BASE INSTALLATION PROCESS	7A
04. PROGRAMMING	
PROGRAMMING AND DELETE REMOTE CONTROLS	7B
P MENUS	8A
E MENUS	8B
05. PROGRAMMING "P"	
P0	9A
P1 - P2 - P3	9B
P4 - P5	10A
P6	10B
P7 - P8	11A
P9	11B
06. PROGRAMMING "E"	
E0	11B
E1 - E2 - E3	12A
E4 - E5	12B
E6 - E7	13A
E8 - E9	13B
07. DISPLAY	
DISPLAY INDICATIONS	14A
08. COMPONENTS TEST	
MOTOR 230V/110V	14B
09. TROUBLESHOOTING	
FINAL CONSUMERS INSTRUCTIONS AND SPECIALIZED INSTALLERS	15

01. SAFETY INSTRUCTIONS

	This product is certified in accordance with European Community (EC) safety standards.
	This product complies with Directive 2011/65/EU of the European Parliament and of the Council, of 8 June 2011, on the restriction of the use of certain hazardous substances in electrical and electronic equipment and with Delegated Directive (EU) 2015/863 from Commission.
	(Applicable in countries with recycling systems). This marking on the product or literature indicates that the product and electronic accessories (eg. Charger, USB cable, electronic material, controls, etc.) should not be disposed of as other household waste at the end of its useful life. To avoid possible harm to the environment or human health resulting from the uncontrolled disposal of waste, separate these items from other types of waste and recycle them responsibly to promote the sustainable reuse of material resources. Home users should contact the dealer where they purchased this product or the National Environment Agency for details on where and how they can take these items for environmentally safe recycling. Business users should contact their vendor and check the terms and conditions of the purchase agreement. This product and its electronic accessories should not be mixed with other commercial waste.
	This marking indicates that batteries should not be discarded like other household waste at the end of their useful life. Batteries must be delivered to selective collection points for recycling.
	The different types of packaging (cardboard, plastic, etc.) must be subject to selective collection for recycling. Separate packaging and recycle it responsibly.
	This marking indicates that the product and electronic accessories (eg. charger, USB cable, electronic material, controls, etc.) are susceptible to electric shock by direct or indirect contact with electricity. Be cautious when handling the product and observe all safety procedures in this manual.

01. SAFETY INSTRUCTIONS

GENERAL WARNINGS

- This manual contains very important safety and usage information. Read all instructions carefully before beginning the installation/usage procedures and keep this manual in a safe place that it can be consulted whenever necessary.
- This product is intended for use only as described in this manual. Any other enforcement or operation that is not mentioned is expressly prohibited, as it may damage the product and put people at risk causing serious injuries.
- This manual is intended firstly for specialized technicians, and does not invalidate the user's responsibility to read the "User Norms" section in order to ensure the correct functioning of the product.
- The installation and repair of this product may be done by qualified and specialized technicians, to assure every procedure are carried out in accordance with applicable rules and norms. Nonprofessional and inexperienced users are expressly prohibited of taking any action, unless explicitly requested by specialized technicians to do so.
- Installations must be frequently inspected for unbalance and the wear signals of the cables, springs, hinges, wheels, supports and other mechanical assembly parts.
- Do not use the product if it is necessary repair or adjustment is required.
- When performing maintenance, cleaning and replacement of parts, the product must be disconnected from power supply. Also including any operation that requires opening the product cover.
- The use, cleaning and maintenance of this product may be carried out by any persons aged eight years old and over and persons whose physical, sensorial or mental capacities are lower, or by persons without any knowledge of the product, provided that these are supervision and instructions given by persons with experienced in terms of usage of the product in a safe manner and who understands the risks and dangers involved.

- Children shouldn't play with the product or opening devices to avoid the motorized door or gate from being triggered involuntarily.
- If the power cable is damaged, it must be replaced by the manufacturer, after-sales service or similarly qualified personnel to avoid danger.
- The device must be disconnected from the electrical network when removing the battery.
- Ensure that blocking is avoided between the actuated part and its fixed parts due to the opening movement of the actuated part.

WARNINGS FOR TECHNICIANS

- Before beginning the installation procedures, make sure that you have all the devices and materials necessary to complete the installation of the product.
- You should note your Protection Index (IP) and operating temperature to ensure that is suitable for the installation site.
- Provide the manual of the product to the user and let them know how to handle it in an emergency.
- If the automatism is installed on a gate with a pedestrian door, a door locking mechanism must be installed while the gate is in motion.
- Do not install the product "upside down" or supported by elements do not support its weight. If necessary, add brackets at strategic points to ensure the safety of the automatism.
- Do not install the product in explosive site.
- Safety devices must protect the possible crushing, cutting, transport and danger areas of the motorized door or gate.
- Verify that the elements to be automated (gates, door, windows, blinds, etc.) are in perfect function, aligned and level. Also verify if the necessary mechanical stops are in the appropriate places.
- The control board must be installed on a safe place of any fluid (rain, moisture, etc.), dust and pests.
- You must route the various electrical cables through protective tubes, to protect them against mechanical exertions, essentially on

01. SAFETY INSTRUCTIONS

the power supply cable. Please note that all the cables must enter the control board from the bottom.

- If the automatism is to be installed at a height of more than 2,5m from the ground or other level of access, the minimum safety and health requirements for the use of work equipment workers at the work of Directive 2009/104/CE of European Parliament and of the Council of 16 September 2009.
- Attach the permanent label for the manual release as close as possible to the release mechanism.
- Disconnect means, such as a switch or circuit breaker on the electrical panel, must be provided on the product's fixed power supply leads in accordance with the installation rules.
- If the product to be installed requires power supply of 230Vac or 110Vac, ensure that connection is to an electrical panel with ground connection.
- The product is only powered by low voltage safety with control board (only at 24V motors).
- Parts/products weighing more than 20 kg must be handled with special care due to the risk of injury. It is recommended to use suitable auxiliary systems for moving or lifting heavy objects.
- Pay special attention to the danger of falling objects or uncontrolled movement of doors/gates during the installation or operation of this product.

WARNINGS FOR USERS

- Keep this manual in a safe place to be consulted whenever necessary.
- If the product has contact with fluids without being prepared, it must immediately disconnect from the power supply to avoid short circuits, and consult a specialized technician.
- Ensure that technician has provided you the product manual and informed you how to handle the product in an emergency.
- If the system requires any repair or modification, unlock the automatism, turn off the power and do not use it until all safety

conditions have been met.

- In the event of tripping of circuits breakers or fuse failure, locate the malfunction and solve it before resetting the circuit breaker or replacing the fuse. If the malfunction is not repairable by consult this manual, contact a technician.
- Keep the operation area of the motorized gate free while the gate in in motion, and do not create strength to the gate movement.
- Do not perform any operation on mechanical elements or hinges if the product is in motion.

RESPONSABILITY

- Supplier disclaims any liability if:
 - Product failure or deformation result from improper installation use or maintenance!
 - Safety norms are not followed in the installation, use and maintenance of the product.
 - Instructions in this manual are not followed.
 - Damaged is caused by unauthorized modifications
 - In these cases, the warranty is voided.

MOTORLINE ELECTROCELOS SA.

Travessa do Sobreiro, nº29
4755-474 Rio Côvo (Santa Eugénia)
Barcelos, Portugal

SYMBOLS LEGEND:



• Important safety notices



• Useful information



• Programming information



• Potentiometer information



• Connectors information



• Buttons information

02. CONTROL BOARD

TECHNICAL SPECIFICATIONS

The MC52 is a single-phase control board with built-in radio control system designed for the automation of swing gates.

	110V version	230V version
• Power Supply	110Vac 60Hz	230Vac 50-60Hz
• Flashing light's output	110Vac 60Hz 500W max.	230Vac 50Hz 500W max.
• RGB Flashing light's output	24Vdc 100mA max.	
• Motor's output	110Vac 60Hz 500W max.	230Vac 50-60Hz 500W max.
• Auxiliary accessories output	24Vdc 8W max.	
• Security and remote controls low voltage	24Vdc	
• Working temperature	-25°C to +55°C	
• Incorporated Radio Receiver	433,92 Mhz	
• Remote controls	12bits or Rolling Code	
• Maximum Memory Capacity	100 (full opening) - 100 (pedestrian opening)	
• Control board Dimensions	125mm x 140mm	

LEDs

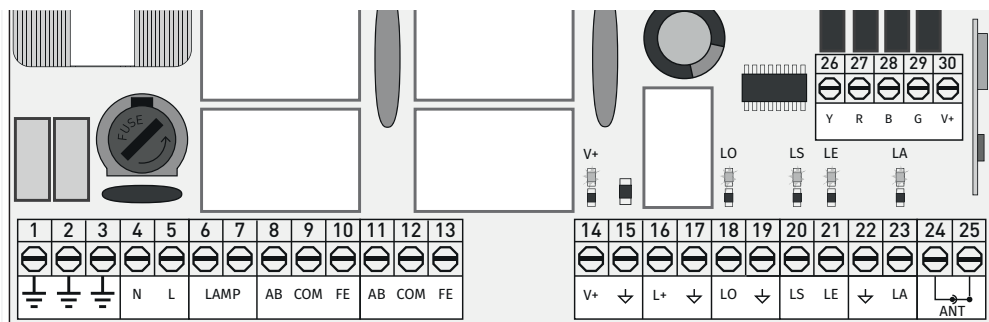

LEDs

- V+ • LED On indicates that the line for V+ output is OK.
- LS • LED On when pedestrian opening is active.
- LO • LED On when full opening is active.
- LA • LED on when the photocell is active (P6 active) or the ↓ LA circuit is closed.
- LE • LED on when the photocells are active (P5 active) or the ↓ LE circuit is closed.

02. CONTROL BOARD

CONNECTORS



Make sure which version you are using (110Vac or 230Vac).

CN1	01 • Grounding connection 02 • Grounding connection 03 • Grounding connection	
	04 • 110/230Vac (Neutral) (N) line input 05 • 110/230Vac (Phase) (L) line input	110/230Vac Power Supply
	06 • Flashing light Output - 110/230Vac 500W 07 • Flashing light Output - 110/230Vac 500W	Courtesy light or Flashing light: This output allows the connection of a courtesy light or a Flashing light.
	08 • Motor 1 Output - Opening - 110/230Vac 500W 09 • Motor 1 Output - Common - 110/230Vac 500W 10 • Motor 1 Output - Closing - 110/230Vac 500W	Motor 1
	11 • Motor 2 Output - Opening - 110/230Vac 500W 12 • Motor 2 Output - Common - 110/230Vac 500W 13 • Motor 2 Output - Closing - 110/230Vac 500W	Motor 2
CN2	14 • 24Vdc 200mA max. Power supply 15 • 24Vdc 200mA max. Power supply	24Vdc Auxiliary Power Supply
	16 • Electric lock Output 12/24Vdc 15W 17 • Electric lock Output 12/24Vdc 15W	Impulse output for 50Ms lock
	18 • Total opening Input (NA) 19 • Common 20 • Pedestrian opening Input (NA)	Pushbuttons: This circuit allows the connection of pushbuttons for full or pedestrian opening.
	21 • Photocells 1 (NC) 22 • Common 23 • Photocells 2 (NC) 24 • Antenna 25 • GND	Safety circuits: This circuit allows the connection of photocells. Its operation depending on the configuration of the P5 and P6 menus (check page 9A).
		Antenna
CN3	26 • Output Y (GND) 27 • Output R (GND) 28 • Output B (GND) 29 • Output G (GND) 30 • Auxiliary output for Flashing light or 24Vdc LED	Open collector for the management of auxiliary functions: Output Y is activated in intermittent mode, only with the gate closed . Output R is activated in intermittent mode, only in the closing phase. Output B is activated in intermittent mode, only during the pause time. Output G is activated in intermittent mode, only during the opening phase.

03. INSTALLATION

INSTALLATION MAP

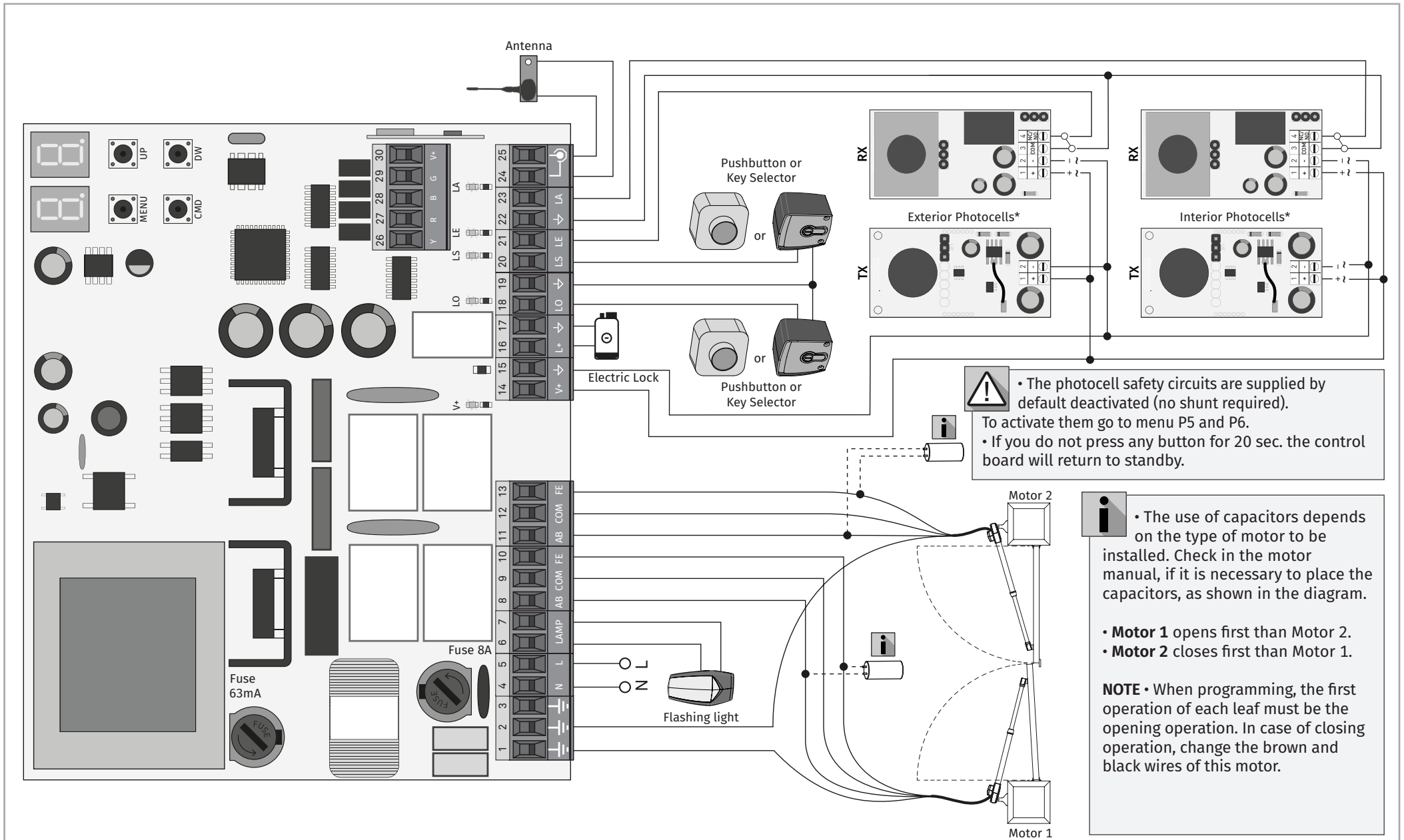

03. INSTALLATION

INSTALLATION MAP - SAFETY SELF-TEST

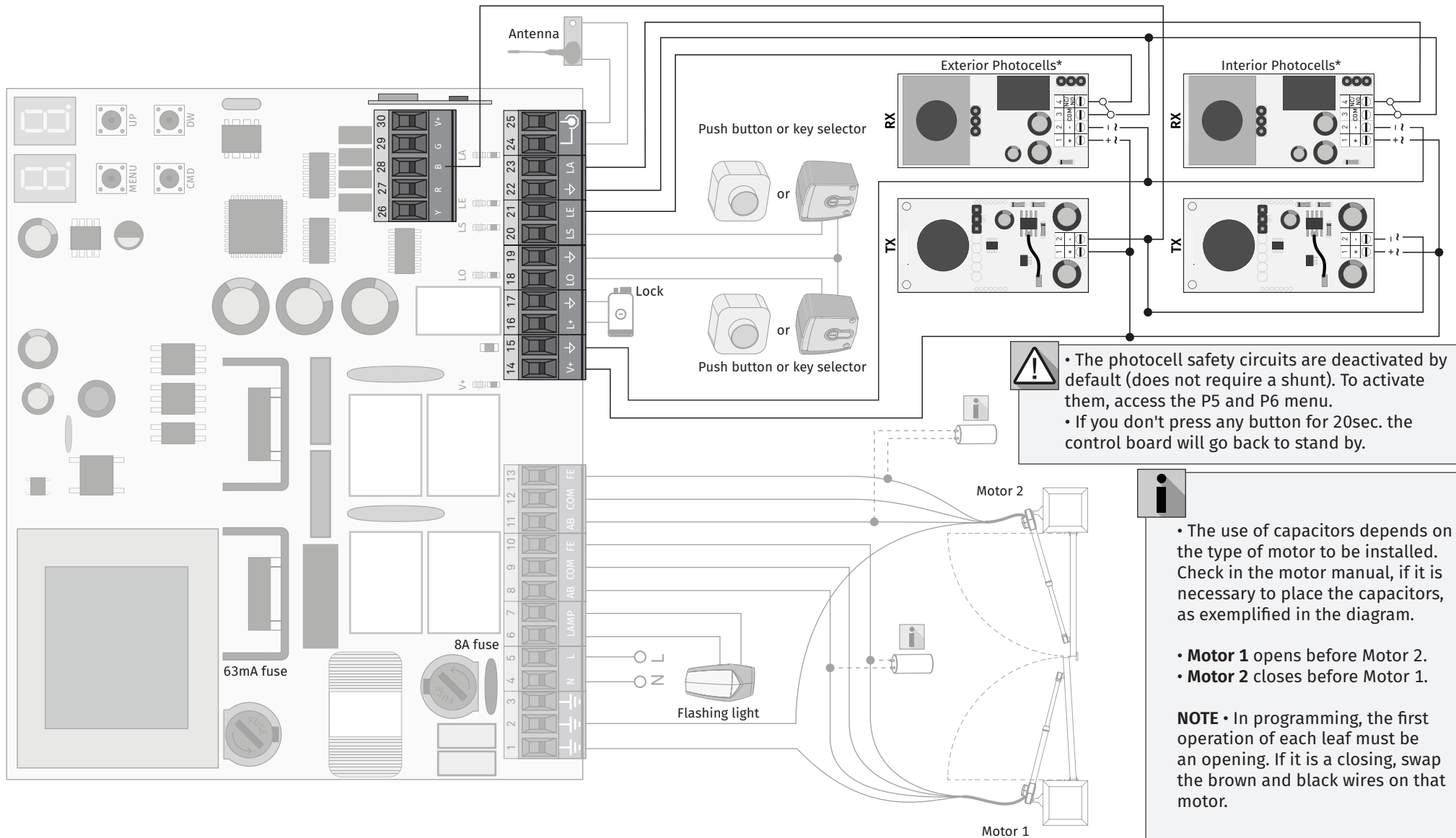

! • The photocell safety circuits are deactivated by default (does not require a shunt). To activate them, access the P5 and P6 menu.
 • If you don't press any button for 20sec. the control board will go back to stand by.

i • The use of capacitors depends on the type of motor to be installed. Check in the motor manual, if it is necessary to place the capacitors, as exemplified in the diagram.
 • **Motor 1** opens before Motor 2.
 • **Motor 2** closes before Motor 1.
NOTE • In programming, the first operation of each leaf must be an opening. If it is a closing, swap the brown and black wires on that motor.

03. INSTALLATION

MCONNECT LINK INSTALLATION (OPTIONAL)

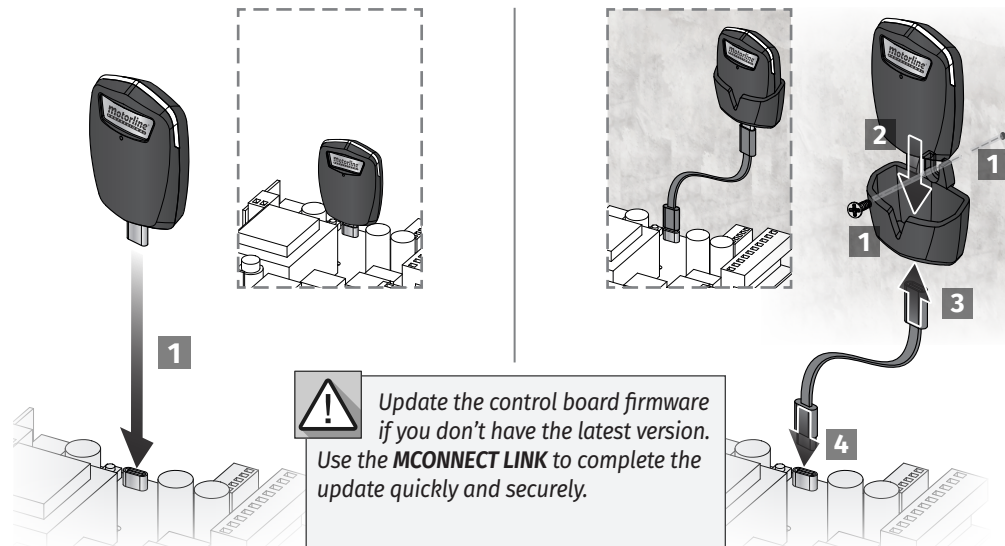

BASE INSTALLATION PROCESS



The installation process assumes that the gate already has mechanical or electrical limit switches installed.

- 01 • Connect all accessories according to the connections diagram (page 5).
- 02 • Connect the control board to a 230V power supply (terminals 4 and 5 - CN1).
- 03 • Check if the gate movement is the same as shown on the display (display indications, page 14A).
- 04 • Make a course programming - menu **P0** (page 9A).
- 05 • If necessary, adjust the deceleration time of the gate at opening and closing - menu **P1** (page 9B).
- 06 • Adjust the gate force - menu **P2** (page 9B).
- 07 • Re-program the course - menu **P0** (page 9A).
- 08 • Enable or disable the use of Photocells in menu **P5** and **P6** (page 10A and 10B).
- 09 • Program a remote control (page 7B).

The control board is now fully configured!
Check the pages of the menu programming if you want to configure other features of the Control board.

04. PROGRAMMING

PROGRAMMING AND DELETE REMOTE CONTROLS

SU Remote controls programming for total opening.

SP Remote controls programming for pedestrian opening.

• PROGRAMMING REMOTE CONTROL

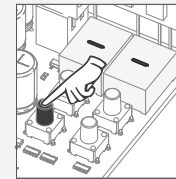

01 • Press the cmd button for 3 sec.

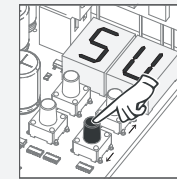

02 • Select (SU) using ↑ ↓.

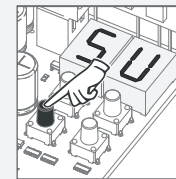

03 • Press cmd once to confirm.

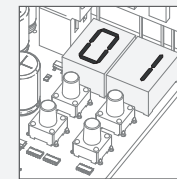

04 • The first free position appears.



05 • Press the remote control button you want to program. The display will blink and move to the next free location.

• ERASE REMOTE CONTROL

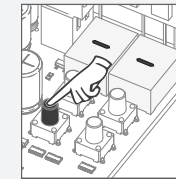

01 • Press the cmd button for 3 sec.

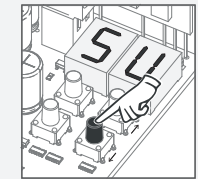

02 • Select (SU) using ↑ ↓.

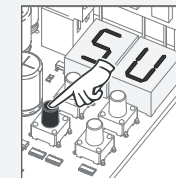

03 • Press cmd once to confirm.

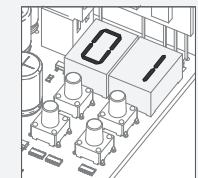

04 • Use ↓ ↑ to select the remote control location you want to delete.

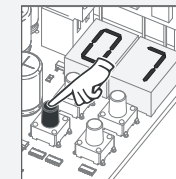

05 • Press cmd for 3 sec and the location will be empty. The display will blink and the position will be free.

• ERASE ALL THE REMOTE CONTROL

01 • Press the cmd button for 10 sec.

02 • The display will show **SU**.

03 • **SU** will flash.

04 • **LU** flashes, confirming that all remote control have been deleted.



If you do not press any button for 20 sec. the control board will return to standby.

04. PROGRAMMING

P MENUS

- We can only enter programming with the gate stopped (electrically).
- To access the P menu press the MENU button for 3 sec.
- Use ↓↑ to navigate through the menus.
- Press MENU when you want to confirm access to a menu.
- Press ↓↑ simultaneously to exit programming.

MENU	FUNCTION	MIN.	MAX.	STATE	FACTORY VALUE	PAGE	
P0	Course programming	-	-	MR Manual programming	-	9A	
				MD 01 1 motor 02 2 motors	02		
P1	Slowdown time adjustment	0s	25s	BR Slowdown in opening (leaf 1) BF Slowdown in closing (leaf 1) BR Slowdown in opening (leaf 2) BF Slowdown in closing (leaf 2)	03	9B	
P2	Force adjustment	0	9	FD Force Adjustment	04	9B	
P3	Pedestrian course time	0s	99s	Pedestrian course time adjustment	10	9B	
P4	Pause time and gate delay	0s	99s	RF Total pause time	00	10A	
		0s	99s	RP Pedestrian pause time	00		
		0s	25s	RD Gate delay in opening	02		
		0s	25s	RC Gate delay in closing	02		
P5	Photocell 1 programming	0	1	LE 00 Disable 01 Active	00	10A	
		0	1	HE 00 In opening 01 In closing	01		
		0	2	HL 00 Reverses 01 Stops 02 Reverse 2 sec. and stops	00		
		0	1	SE 00 Disable photocell test 01 Activate photocell test	00		
		0	1	LR 00 Disable 01 Active	00		
P6	Photocell 2 programming	0	1	HC 00 In opening 01 In closing 02 In opening and closing	00	10B	
		0	2	HL 00 Reverses 01 Stops 02 Reverse 2 sec. and stops 03 Stop, continue if you remove the obstacle	01		
		0	1	SE 00 Disable photocell test 01 Activate photocell test	00		
P7	Operating logic	0	2	00 Automatic mode 01 Step by step mode 02 Condominium mode	00	11A	
		0	2	00 Flashing (opening and closing) 01 Step by step mode	00	11A	
				02 Courtesy light			
P9	Distance programming	0	1	00 Distance PGM OFF 01 Distance PGM ON	00	11B	

04. PROGRAMMING

E MENUS

MENU	FUNCTION	MIN.	MAX.	STATE	FACTORY VALUE	PAGE.		
E0	Human presence	0	1	HP 00 Deactivates Human presence 01 Activates Human presence PL 00 Disables push buttons mode 01 Activates push buttons mode	00	11B		
E1	Soft start	0	1	00 Deactivates Soft start 01 Activates Soft start	00	12A		
E2	Courtesy light time / Pre-flashing light	0	99	LE Adjust courtesy light time (minutes) PP Adjust pre-flashing light time (seconds)	00	12A		
E3	Follow me	-	-	00 Deactivates follow me 01 Follow me does not act when the gate is opening. It only works when it is open. 02 Follow me acts when the gate is open and when it is open.	00	12A		
E4	Course time adjustment	0m	3m	Opening course time (minutes) - Leaf 1	00	12B		
		0s	59s	Opening course time (seconds) - Leaf 1	30			
		0m	3m	Closing course time (minutes) - Leaf 1	00			
		0s	59s	Closing course time (seconds) - Leaf 1	30			
		0m	3m	Opening course time (minutes) - Leaf 2	00			
		0s	59s	Opening course time (seconds) - Leaf 2	30			
		0m	3m	Closing course time (minutes) - Leaf 2	00			
		0s	59s	Closing course time (seconds) - Leaf 2	30			
E5	Brake/Push	0	1	Eb 00 Disables electric brake 01 Active electric brake Pb 00 Disables opening push 01 Active opening push Pc 00 Disables closing push 01 Active closing push	00	12B		
		E6	Deceleration Speed	0	9	Deceleration Speed adjustment	05	13A
		E7	Manuevers counter	-	-	Shows the number of manuevers	-	13A
		E8	Reset - Restore factory settings	0	1	00 Deactivated 01 Reset activated	00	13B
E9	RGB Output			-	-	00 Continued output 01 Intermittent output	00	13B
		REMOTE CONTROL						
E0	Remote control programming for total opening.					7B		
E1	Remote control programming for pedestrian opening.					7B		

04. PROGRAMMING "P"

P0 COURSE PROGRAMMING

PA	P0
Course Manual Programming This menu allows you to manually set the course of the leaf/leaves.	Number of Motors Allows you to define the number of motors connected to the control board
Default value (NA)	Default value (02)

DIRECTION OF DISPLAY ROTATION	COURSE PROGRAMMING OF TWO MOTORS
00	Normal rotation - leaf 1 starts opening (normal speed) Slow rotation - leaf 1 goes into opening slowdown (slowdown speed)
01	Normal rotation - leaf 1 stops and leaf 2 starts opening (normal speed) Slow rotation - leaf 2 goes into opening slowdown (slowdown speed)
02	Normal rotation - leaf 2 stops and starts closing (normal speed) Slow rotation - leaf 2 goes into closing speed (slowdown speed)
03	Normal rotation - leaf 2 stops and leaf 1 starts opening (normal speed) Slow rotation - leaf 1 goes into closing slowdown (slowdown speed)
COURSE PROGRAMMING OF ONE MOTOR (PEDESTRIAN)	
04	Normal rotation - leaf starts opening (normal speed) Slow rotation - the leaf goes into opening slowdown (slowdown speed)
05	Normal rotation - the leaf stops and starts closing (normal speed)
06	Slow rotation - the leaf goes into closing slowdown (slowdown speed)

Manual programming:

- 01 • Press MENU for 2 sec. until **P0** appears.
- 02 • Press MENU once until **PA** appears.
- 03 • Press MENU (or remote control) to start programming the opening time.

2 MOTORS (PA = 02)	1 MOTOR (PEDESTRIAN) (PA = 01)
04 • Press MENU to start slowdown. 05 • Press MENU to stop leaf 1 (leaf 2 starts opening automatically). 06 • Press MENU to start slowdown. 07 • Press MENU to finish opening and start closing leaf 2. 08 • Press MENU to start slowdown. 09 • Press MENU to stop leaf 2 (leaf 1 starts closing automatically). 10 • Press MENU to start slowdown. 11 • Press MENU to finish closing leaf 1.	04 • Press MENU to start the opening slowdown of the leaf. 05 • Press MENU to stop the leaf and start programming the closing time. 06 • Press MENU to start the closing slowdown of the leaf. 07 • Press MENU once to display P0 , leaf 1 stops. 08 • Use UP and DW to display P1 to exit programming mode. 09 • Use UP and DW to stay in Standby.

Display will show **00** signaling that leaves are closed.



You can use the remote instead of the MENU button. Whenever a leaf touches a stopper, wait 1 second before clicking on the MENU.

05. PROGRAMMING "P"

P1 DECELERATION TIME ADJUSTMENT



Whenever there is a reversal of the direction of travel, the preset deceleration time is increased by 2 sec. up to 25 sec. maximum.

This menu allows you to set the deceleration time of each leaf at opening and closing.

0A	0F
Slowing down on opening leaf 1 It allows to define the time that the gate will act with slowdown in the opening.	Slowing down on closing leaf 1 It allows to define the time that the gate will act with slowdown in the closing.
0B	0E
Slowing down on opening leaf 2 It allows to define the time that the gate will act with slowdown in the opening.	Slowing down on closing leaf 2 It allows to define the time that the gate will act with slowdown in the closing.
(Default value 3)	

- 01 • Press MENU for 2 sec. until it appears **P0**.
- 02 • Use UP until appears **P1**.
- 03 • Press Menu will appear **0A**. Use UP or DW to navigate the parameters.
- 04 • Press MENU to edit the chosen parameter value.
- 05 • The currently set value appears. Use UP and DW to change the value.
- 06 • Press MENU to save the new value.

05. PROGRAMMING "P"

P2 FORCE ADJUSTMENT

This menu allows you to set the force that is injected into the motor when it moves at normal speed. The default value is 4.

- 01 • Press MENU for 2 sec. until it appears **P0**.
- 02 • Use UP until appears **P2**.
- 03 • Press Menu will appear **F0**.
- 04 • Press MENU to edit value.
- 05 • The currently set value appears. Use UP and DW to change the value.
- 06 • Press MENU to save the new value.

05. PROGRAMMING "P"

P3 PEDESTRIAN COURSE TIME

Allows you to set the pedestrian course time. The default value is 10.

- 01 • Press MENU for 2 sec. until it appears **P0**.
- 02 • Use UP until appears **P3**.
- 03 • Press Menu the value set by the factory will appear.
- 04 • Press MENU to edit the value.
- 05 • Use UP and DW to change the value.



When the values are at zero, there is no automatic closing.

AF	AP	AE	AO
Full closing pause time adjustment This menu allows you to set the total opening pause time.	Pedestrian closing pause time adjustment Allows you to set the pause time at the pedestrian opening.	Gate delay in closing Allows you to set the delay time for closing leaf 1 relative to leaf 2.	Gate delay in opening Allows you to set the delay time for opening leaf 2 relative to leaf 1.
min. 0s max. 99s (Default value 0)	min. 0s max. 99s (Default value 0)	min. 0s max. 25s (Default value 2)	min. 0s max. 25s (Default value 2)

- 01 • Press MENU for 2 sec. until it appears P0.
- 02 • Use UP until appears P4.
- 03 • Press Menu will appear AF. Use UP or DW to navigate the parameters.
- 04 • Press MENU to edit the chosen parameter value.
- 05 • The currently set value appears. Use UP and DW to change the value.
- 06 • Press MENU to save the new value.

EE	HC	HL	SE
00 (deactivate) 01 (active) Enable or disable security.	00 (photocells in opening) 01 (photocells in closing) Define if this security will act on opening or closing.	00 (the movement of the gate is reversed) 01 (gate movement stops and resumes 5 sec after security is disabled) 02 (the movement of the gate reverses for 2 seconds and stops) Define the behavior that the gate will have when this security is activated.	00 (disables Photocell test) 01 (enables Photocell test) Allows you to enable or disable the safety self-test function.
(Default value 0)			

- 01 • Press MENU for 2 sec. until it appears P0.
- 02 • Use UP until appears P5.
- 03 • Press Menu will appear EE. Use UP or DW to navigate the parameters.
- 04 • Press MENU to edit the chosen parameter value.
- 05 • The currently set value appears. Use UP and DW to change the value.
- 06 • Press MENU to save the new value.

LR	HC*	HL	SE
00 (deactivate) 01 (active) Enable or disable security.	In opening and closing 00 (photocells in opening) 01 (photocells in closing) 02 (In opening - Stops when the photocells are interrupted and resumes opening when they are released; In closing: Stops and reopens as soon as the photocells are released) Allows you to define whether the safety will act on opening or closing.	00 (the movement of the gate is reversed) 01 (gate movement stops and resumes 5 sec after security is disabled) 02 (the movement of the gate reverses for 2 seconds and stops) 03 (the gate stops when there is an obstacle between the photocells, continuing the movement as soon as the obstacle is removed) Define the behavior that the gate will have when this security is activated.	00 (disables Photocell test) 01 (enables Photocell test) Allows you to enable or disable the safety self-test function.
(Default value 0)			

***Note:** If you activate parameter 02 in P6 →HC, the P6 →HL menu no longer functions.

- 01 • Press MENU for 2 sec. until it appears P0.
- 02 • Use UP until appears P5.
- 03 • Press Menu will appear LR. Use UP or DW to navigate the parameters.
- 04 • Press MENU to edit the chosen parameter value.
- 05 • The currently set value appears. Use UP and DW to change the value.
- 06 • Press MENU to save the new value.



It is recommended to activate the Photocells test before starting operation. This test makes it possible to protect the movement of the gate in case of any failure of the Photocells.

05. PROGRAMMING "P"

P7 OPERATING LOGIC

This menu allows to set the operating logic of the automation.

00	01	02
Automatic Mode Whenever there is an order the movement is reversed.	Step by step mode 1st impulse - OPEN 2nd impulse - STOP 3rd impulse - CLOSE 4th impulse - STOP If it is fully open and timed, it closes.	Condominium Mode Does not respond to orders during opening and pause time.
(Default value 00)		

- 01 • Press MENU for 2 sec. until it appears P0.
- 02 • Use UP until appears P7.
- 03 • Press Menu will appear 00.
- 04 • Press MENU to edit the value.
- 05 • Use UP and DW to change the value.
- 06 • Press MENU to save the new value.

05. PROGRAMMING "P"

P8 FLASHING LIGHT

This menu allows you to set the operation mode of the flashing light (LAMP).

00	01	02
Flashing (opening and closing) During the opening/closing movement of the gate, the flashing light will work intermittently.	Step by step mode During the opening/closing movement of the gate, the flashing light is permanently on.	Courtesy light The light will stay on for the time set in the E2 menu.
(Default value 00)		

- 01 • Press MENU for 2 sec. until it appears P0.
- 02 • Use UP until appears P8.
- 03 • Press Menu will appear 00.
- 04 • Press MENU to edit the value.
- 05 • Use UP and DW to change the value.
- 06 • Press MENU to save the new value.

05. PROGRAMMING "P"

P9 REMOTE PROGRAMMING

Allows you to activate/deactivate the programming of new remote controls without directly accessing the control board, using a previously memorized remote control.

- 01 • Press MENU for 2 sec. until it appears P9.
- 02 • Use UP until appears P0.
- 03 • Press Menu will appear 00.
- 04 • Press MENU to edit the value.
- 05 • Use UP and DW to change the value.
- 06 • Press MENU to save the new value.

(Default value 00)

Remote Programming Operation (PGM ON):



- Press the buttons indicated in the image simultaneously for 10 seconds and the flashing light will flash (the 1st free position appears in the display).
- Each time you store 1 remote controls, the control board will exit remote programming. If you want to memorize more remote control, you will always have to repeat the process of pressing the remote controls buttons simultaneously for 10 seconds for each new remote control.

06. PROGRAMMING "E"

E0 HUMAN PRESENCE

HP	PL									
00 (deactivate) 01 (active) Enable or disable human presence.	00 (deactivate) 01 (active) Allows you to activate or deactivate the pushbutton mode.									
Note • With active human presence RF remote controls do not work.	<table border="1"> <thead> <tr> <th></th> <th>LS</th> <th>LO</th> </tr> </thead> <tbody> <tr> <td>01 ACTIVE</td> <td>Full closing</td> <td>Full opening</td> </tr> <tr> <td>00 DEACTIVATE</td> <td>Pedestrian maneuvers</td> <td>Total maneuvers</td> </tr> </tbody> </table>		LS	LO	01 ACTIVE	Full closing	Full opening	00 DEACTIVATE	Pedestrian maneuvers	Total maneuvers
	LS	LO								
01 ACTIVE	Full closing	Full opening								
00 DEACTIVATE	Pedestrian maneuvers	Total maneuvers								
(Default value 00)										

- 01 • Press MENU for 10 sec. until it appears E0.
- 02 • Press Menu will appear HP. Use UP or DW to navigate the parameters.
- 03 • Press MENU to edit the chosen parameter value.
- 04 • The currently set value appears. Use UP and DW to change the value.
- 05 • Press MENU to save the new value.

06. PROGRAMMING "E"

E.1 SOFT START

Enables or disables the soft start. With the soft start function activated, at each start of movement the control board will control the motor start, increasing the speed gradually in the first second of operation.

The default value is 0 (deactivated).

- 01 • Press MENU for 10 sec. until it appears **E0**.
- 02 • Use UP until appears **E1**.
- 03 • Press Menu will appear **00**.
- 04 • Press MENU to edit the value.
- 05 • Use UP and DW to change the value.
- 06 • Press MENU to save the new value.

06. PROGRAMMING "E"

E.2 TIME OF COURTESY LIGHT/PRE-FLASHING LIGHT



To adjust the courtesy light time (Lt) it is necessary to select option 2 in P8.

Allows you to adjust the courtesy light time for closed, open and stopped gates.

00

Opening course time (minutes)

(Default value 0)

Allows you to adjust the gate movement signaling time before it starts.

PP

Closing course time (seconds)

(Default value 0)

- 01 • Press MENU for 10 sec. until it appears **E0**.
- 02 • Use UP until appears **E2**.
- 03 • Press Menu will appear **00**. Use UP or DW to navigate parameters.
- 04 • Press MENU to edit the value.
- 05 • Use UP and DW to change the value.
- 06 • Press MENU to save the new value.

06. PROGRAMMING "E"

E.3 FOLLOW ME

Allows you to activate the Follow me option. With this option activated, the control board, when in the open position or in opening, gives a closing order of 5 sec. after the safety device detects the passage of an object / user.

00 function disabled | 01 function activated after opening | 02 function activated on opening

(Default value 00)

- 01 • Press MENU for 10 sec. until it appears **E0**.
- 02 • Use UP until appears **E3**.
- 03 • Press Menu will appear **00**.
- 04 • Press MENU to edit the value.
- 05 • Use UP and DW to change the value.
- 06 • Press MENU to save the new value.

06. PROGRAMMING "E"

E.4 COURSE TIME ADJUSTMENT

It allows to adjust the working time for the opening and closing courses of the two leaves.

Leaf 1

00	05	00	05
Opening course time (minutes)	Opening course time (seconds)	Closing course time (minutes)	Closing course time (seconds)
(Default value 0)	(Default value 15)	(Default value 0)	(Default value 15)

Leaf 2

00	05	00	05
Opening course time (minutes)	Opening course time (seconds)	Closing course time (minutes)	Closing course time (seconds)
(Default value 0)	(Default value 15)	(Default value 0)	(Default value 15)

- 01 • Press MENU for 10 sec. until it appears **E0**.
- 02 • Use UP until appears **E4**.
- 03 • Press Menu will appear **00**. Use UP or DW to navigate the parameters.
- 04 • Press MENU to edit the chosen parameter value.
- 05 • The currently set value appears. Use UP and DW to change the value.
- 06 • Press MENU to save the new value.

06. PROGRAMMING "E"

E.5 BRAKE/PUSH

It allows to activate or deactivate the functions of the electric brake, the lock's operating mode and to activate or deactivate pushes on opening and closing.

00	00	00
01	01	01
Allows you to activate the electronic brake.	Allows you to activate the opening push (ram).	Allows you to activate the closing push.
(Default value 0)	(Default value 0)	(Default value 0)

- 01 • Press MENU for 10 sec. until it appears **E0**.
- 02 • Use UP until appears **E5**.
- 03 • Press Menu will appear **00**. Use UP or DW to navigate the parameters.
- 04 • Press MENU to edit the chosen parameter value.
- 05 • The currently set value appears. Use UP and DW to change the value.
- 06 • Press MENU to save the new value.

06. PROGRAMMING "E"

DECELERATION SPEED

This menu allows you to adjust the deceleration speed.
The higher the slowdown level, the faster the slowdown.
The default value is 4.

- 01 • Press MENU for 10 sec. until it appears **E0**.
- 02 • Use UP until appears **E6**.
- 03 • Press Menu the value set by the factory will appear.
- 04 • Press MENU to edit the value.
- 05 • Use UP and DW to change the value.
- 06 • Press MENU to save the new value.

06. PROGRAMMING "E"

E7 MANUEVERS COUNTER

This menu allows you to view the number of maneuvers performed.
(complete maneuver means opening and closing).

⚠ **Resetting the control board does not clear the maneuver count.**

Example: 13456 maneuvers

01- Hundred thousand / 34- Thousands / 56- Dozens

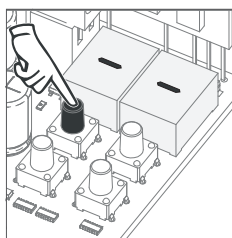

01 • Press MENU for 10 seconds.

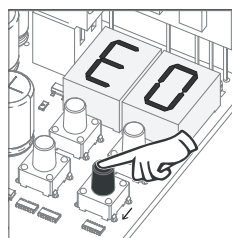

02 • E0 appears.
Press UP until appears E7.

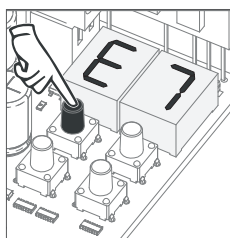

03 • Press MENU.

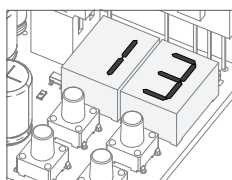

10 hundred thousand

→ display flashes

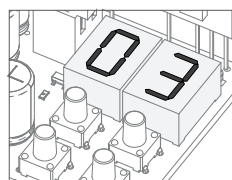

20 thousands

→ display flashes

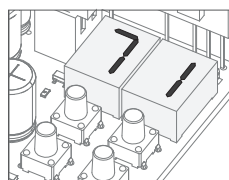

30 dozens

04 • The maneuvers count is displayed in the following order (example: 130 371):

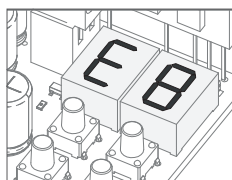

05 • E8 appears.

06. PROGRAMMING "E"

E8 RESET - RESET FACTORY VALUES

This menu allows you to reset to factory defaults.
The default value is 0 (deactivated).

- 01 • Press MENU for 10 sec. until it appears **E0**.
- 02 • Use UP until appears **E8**.
- 03 • Press Menu will appear **00**.
- 04 • Press MENU to edit the value.
- 05 • Use UP and DW to change the value.
- 06 • Press MENU to save the new value.

06. PROGRAMMING "E"

E9 RGB OUTPUT

This menu allows you to set the operation mode of RGB outputs.
The default value is 0 (continuous output).

- 01 • Press MENU for 10 sec. until it appears **E0**.
- 02 • Use UP until appears **E9**.
- 03 • Press Menu will appear **00**.
- 04 • Press MENU to edit the value.
- 05 • Use UP and DW to change the value.
- 06 • Press MENU to save the new value.

07. DISPLAY

DISPLAY INDICATIONS

88	IN STOP POSITION, FULLY OPENED
88	IN STOP POSITION, MIDDLE POSITION
88	IN STOP POSITION, FULLY CLOSED
00	TOTAL OPENING BUTTON PRESSED
05	PEDESTRIAN OPENING BUTTON PRESSED
0P	CONTROL BOARD PERFORMS OPENING COURSE
88	CONTROL BOARD PERFORMS CLOSING COURSE
F0	END OF OPENING COURSE TIME
F0	END OF CLOSING COURSE TIME
00	ALL REMOTE CONTROLS DELETED
00 01 02	REMOTE CONTROL ADDED IN THE INDICATED POSITION
8E	OBSTRUCTED PHOTOCELL
8A	OBSTRUCTED PHOTOCELL
8E	IN PAUSE TIME
8P	IN PEDESTRIAN PAUSE TIME
8P	IN PRE-FLASHING LIGHT TIME
5E	PHOTOCELL TEST FAILED

Simplified EU Declaration of Conformity

The undersigned **MOTORLINE ELECTROCELOS, S.A.**, with registered office at **Travessa do Sobreiro, n.º 29, 4755-474 Rio Côvo (Santa Eugénia), Barcelos**, declares that the present type of radio equipment - **MC52 Control board** - complies with the Directive 2014/53/EU.

The full text of the declaration of conformity is available at the following internet address:

<https://motorline.pt/certification/mc52>



08. COMPONENTS TEST

230V/110V MOTOR

To detect if the problem is in the control board or in the motor, sometimes it's necessary to conduct tests with a direct connection to a 230V/110V power supply.

For this, it's necessary to interpose a capacitor on the connection so that the motor can work (check the capacitor type to be used in the product's manual). In the below diagram is shown how this connection must be made and how to merge the different component wires.

NOTES:

- To perform the tests you don't need to remove the automatism from its place, because this way you can understand if the automatism, directly connected to the power, can function correctly.
- A new capacitor should be used during this test to ensure that the problem is not in the capacitor.

01 • Connect the power wires to the terminal as shown below.

02 • Connect the automation wires to the terminal, interleaving a capacitor into the opening and closing wires.

03 • After these connections are complete, connect to a 230V/110V power socket, depending on the motor/control board being tested.



The use of capacitors depends on the type of motor to be installed. Check in the motor manual, if it is necessary to place the capacitors, as shown in the diagram.

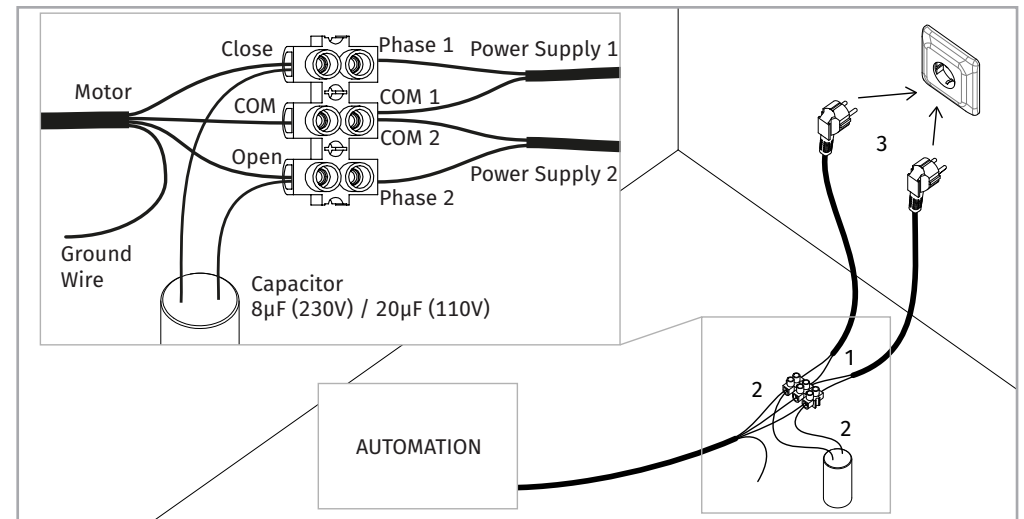

All tests must be performed by qualified personnel due to serious danger associated with the misuse of electrical systems.

09. TROUBLESHOOTING

INSTRUCTIONS FOR FINAL CONSUMERS

INSTRUCTIONS FOR TECHNICIANS

Anomaly	Procedure	Behavior	Procedure II	Discovering the origin of the problem			
• Motor doesn't work.	• Make sure you have power supply connected to control board and if it is working properly.	• Still not working.	• Consult a qualified MOTORLINE technician.	1 • Open control box and check if it has 230V power supply; 2 • Check input fuses;	3 • Disconnect motors from control board and test them by connecting directly to power supply in order to find out if they have problems (see page 11B).	4 • If the motors work, the problem is on the control board. Pull it out and send it to our MOTORLINE technical services for diagnosis;	5 • If the motors don't work, remove them from installation site and send to our MOTORLINE technical services for diagnosis.
• Motor doesn't move but makes noise.	• Unlock motor and move the gate by hand to check for mechanical problems on the movement.	• Is the gate stuck?	• Consult a qualified gates technician.	1 • Check all motion axis and associated motion systems related with the gate and automation (rails, pulleys, bolts, hinges, etc) to find out what is the problem.			
		• The gate moves easily?	• Consult a qualified MOTORLINE technician.	1 • Check capacitors, testing motor with new capacitor; 2 • If capacitors are not the problem, disconnect motors	from control board and test them by connecting directly to power supply in order to find out if they have problems (see page 11B).	3 • If the motors work, the problem is with control board. Pull it out and send it to our MOTORLINE technical services for diagnosis;	4 • If the motors don't work, remove them from installation site and send to our MOTORLINE technical services for diagnosis.
• Motors open but doesn't close.	• Unlock motor and move the gate by hand to closed position. Block the motor again and turn off power supply for 5 seconds. Reconnect it and send order to open gate using remote control.	• Gate opened but didn't close again.	1 • Check if there is any obstacle in front of the photocells; 2 • Check if any of the control devices (Key Selector, Pushbutton, Video Intercom, etc.) are stucked and sending permanent signal to control board; 3 • Consult a qualified MOTORLINE technician.	All control boards MOTORLINE have LEDs that easily allow to conclude which devices are with anomalies. All safety devices LEDs (Le) in normal situations remain On. All "START" circuits LEDs in normal situations remain Off. If LEDs devices are not all On, there is some security systems malfunction (photocells, safety edges). If "START" circuits LEDs are turn (Op and Cl), there is a control device sending permanent signal.		A) SECURITY SYSTEMS: 1 • Close with a shunt all safety systems on the control board (check manual of the control board in question). If the automated system starts working normally check for the problematic device. 2 • Remove one shunt at a time until you find the malfunction device. 3 • Replace it for a functional device and check if the motor works correctly with all the other devices. If you find another one defective, follow the same steps until you find all the problems.	B) START SYSTEMS: 1 • Disconnect all wires connected to the START connector. 2 • If the LED turned OFF, try reconnecting one device at a time until you find the defective device. NOTE: In case procedures described in sections A) and B) don't result, remove control board and send to our MOTORLINE technical services for diagnosis.
• Motor doesn't make complete course.	• Unlock motor and move gate by hand to check for mechanical problems on the gate.	• Encountered problems?	• Consult an experienced gates expert.	1 • Check all motion axis and associated motion systems related with the gate and automation (rails, pulleys, bolts, hinges, etc) to find out what is the problem.			
		• The gate moves easily?	• Consult a qualified MOTORLINE technician.	1 • Check capacitors, testing with new capacitors; 2 • If capacitors are not the problem, disconnect motor from control board and test it by connecting directly to power supply in order to find out if it is broken; 3 • If the motor(s) doesn't work,	remove it from installation site and send to our MOTORLINE technical services for diagnosis. 4 • If motor work well and move gate at full force during the entire course, the problem is with control board. Set force using trimmer on the board. Make a new working time programming, giving enough time for opening and closing with	appropriate force (consult control board manual). 5 • If this doesn't work, remove control board and send it to MOTORLINE technical services.	NOTE: Setting force of the control board should be enough to make the gate open and close without stopping, but should stop and invert with a little effort from a person. In case of safety systems failure, the gate shall never cause physical damaged to obstacles (vehicles, people, etc.).