

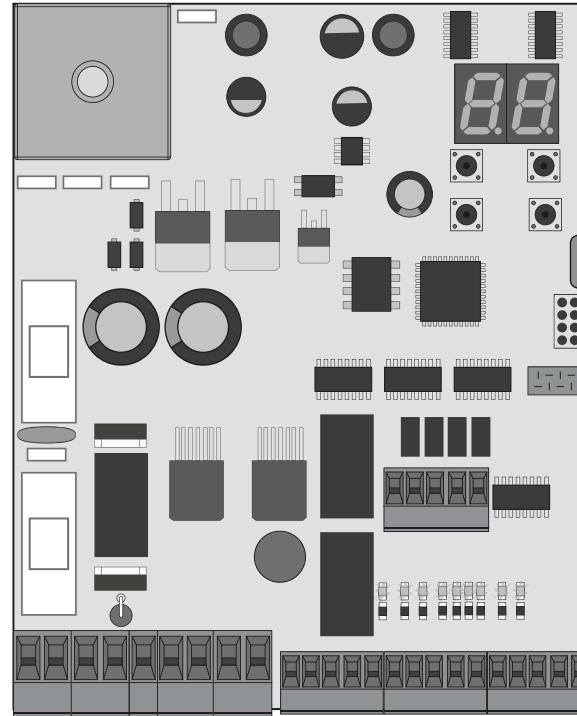

MC60

USER'S AND INSTALLER'S MANUAL



01. SAFETY INSTRUCTIONS	3
02. CONTROL BOARD	
CHARACTERISTICS	5B
CONNECTORS	6A
BUTTONS AND LEDs	6B
03. CONNECTION SCHEME	
SLIDING GATES [SC]	7
SECTIONAL DOORS [SE]	8
BARRIERS [BR]	9
AUTOMATIC BOLLARDS [PL]	10
MASTER-SLAVE	11
ACTIVE PHOTOCELL TEST	12
04. INSTALLATION	
INSTALLATION OF MCONNECT LINK (OPTIONAL)	13A
ESSENTIAL STEPS FOR INSTALLATION	13B
REMOTE CONTROLS	14A
FUNCTIONS	14B
EXCLUSIVE FACTORY VALUES	14B
FUNCTIONS MENU "P"	15A
FUNCTIONS MENU "E"	15B
05. PROGRAMMING "P"	
P0-COURSE PROGRAMMING	16A
P1-SLOWDOWN TIME ADJUSTMENT	16B
P2-FORCE AND SENSITIVITY ADJUSTMENT	16B
P3-PEDESTRIAN COURSE TIME	17A
P4-PAUSE TIME	17A
P5-PHOTOCELLS 1 PROGRAMMING	17B
P6-PHOTOCELLS 2 PROGRAMMING	18A
P7-OPERATING LOGIC	18A
P8-FLASHING LIGHT	18B
P9-DISTANCE PROGRAMMING	18B
06. PROGRAMMING "E"	
E0-HUMAN PRESENCE PUSH BUTTON	19A
E1-SOFT START	19B

E2-COURTESY LIGHT TIME	19B
E3-FOLLOW ME	20A
E4-COURSE TIME ADJUSTMENT	20A
E5-BRAKE/LOCK/PUSH	20B
E6-SLOWDOWN SPEED	20B
E7-MANUEVERS COUNTER	21A
E8-RESET - RESET FACTORY VALUES	21B
E9-RGB OUTPUT	21B
07. DISPLAY	
DISPLAY INDICATIONS	22
08. TROUBLESHOOTING	
INSTRUCTIONS FOR FINAL CONSUMERS AND SPECIALIZED INSTALLERS	23





Simplified EU Declaration of Conformity

The undersigned **MOTORLINE ELECTROCELOS, S.A.**, with registered office at **Travessa do Sobreiro, n.º 29, 4755-474 Rio Côvo (Santa Eugénia), Barcelos**, declares that the present type of radio equipment - **MC60 Control board** - ecomplies with the Directive 2014/53/EU.

The full text of the declaration of conformity is available at the following internet address:

<https://motorline.pt/certification/mc60>



CE	This product is certified in accordance with European Community (EC) safety standards.
RoHS	This product complies with Directive 2011/65/EU of the European Parliament and of the Council, of 8 June 2011, on the restriction of the use of certain hazardous substances in electrical and electronic equipment and with Delegated Directive (EU) 2015/863 from Commission.
	(Applicable in countries with recycling systems). This marking on the product or literature indicates that the product and electronic accessories (eg. Charger, USB cable, electronic material, controls, etc.) should not be disposed of as other household waste at the end of its useful life. To avoid possible harm to the environment or human health resulting from the uncontrolled disposal of waste, separate these items from other types of waste and recycle them responsibly to promote the sustainable reuse of material resources. Home users should contact the dealer where they purchased this product or the National Environment Agency for details on where and how they can take these items for environmentally safe recycling. Business users should contact their vendor and check the terms and conditions of the purchase agreement. This product and its electronic accessories should not be mixed with other commercial waste.
	This marking indicates that batteries should not be discarded like other household waste at the end of their useful life. Batteries must be delivered to selective collection points for recycling.
	The different types of packaging (cardboard, plastic, etc.) must be subject to selective collection for recycling. Separate packaging and recycle it responsibly.
	This marking indicates that the product and electronic accessories (eg. charger, USB cable, electronic material, controls, etc.) are susceptible to electric shock by direct or indirect contact with electricity. Be cautious when handling the product and observe all safety procedures in this manual.

GENERAL WARNINGS

- This manual contains very important safety and usage information. Read all instructions carefully before beginning the installation/usage procedures and keep this manual in a safe place that it can be consulted whenever necessary.
- This product is intended for use only as described in this manual. Any other enforcement or operation that is not mentioned is expressly prohibited, as it may damage the product and put people at risk causing serious injuries.
- This manual is intended firstly for specialized technicians, and does not invalidate the user’s responsibility to read the “User Norms” section in order to ensure the correct functioning of the product.
- The installation and repair of this product may be done by qualified and specialized technicians, to assure every procedure are carried out in accordance with applicable rules and norms. Nonprofessional and inexperienced users are expressly prohibited of taking any action, unless explicitly requested by specialized technicians to do so.
- Installations must be frequently inspected for unbalance and the wear signals of the cables, springs, hinges, wheels, supports and other mechanical assembly parts.
- Do not use the product if it is necessary repair or adjustment is required.
- When performing maintenance, cleaning and replacement of parts, the product must be disconnected from power supply. Also including any operation that requires opening the product cover.
- The use, cleaning and maintenance of this product may be carried out by any persons aged eight years old and over and persons whose physical, sensorial or mental capacities are lower, or by persons without any knowledge of the product, provided that these are supervision and instructions given by persons with experienced in terms of usage of the product in a safe manner and who understands the risks and dangers involved.

- Children shouldn't play with the product or opening devices to avoid the motorized door or gate from being triggered involuntarily.
- If the power cable is damaged, it must be replaced by the manufacturer, after-sales service or similarly qualified personnel to avoid danger.
- The device must be disconnected from the electrical network when removing the battery.
- Ensure that blocking is avoided between the actuated part and its fixed parts due to the opening movement of the actuated part.

WARNINGS FOR TECHNICIANS

- Before beginning the installation procedures, make sure that you have all the devices and materials necessary to complete the installation of the product.
- You should note your Protection Index (IP) and operating temperature to ensure that is suitable for the installation site.
- Provide the manual of the product to the user and let them know how to handle it in an emergency.
- If the automatism is installed on a gate with a pedestrian door, a door locking mechanism must be installed while the gate is in motion.
- Do not install the product "upside down" or supported by elements do not support its weight. If necessary, add brackets at strategic points to ensure the safety of the automatism.
- Do not install the product in explosive site.
- Safety devices must protect the possible crushing, cutting, transport and danger areas of the motorized door or gate.
- Verify that the elements to be automated (gates, door, windows, blinds, etc.) are in perfect function, aligned and level. Also verify if the necessary mechanical stops are in the appropriate places.
- The control board must be installed on a safe place of any fluid (rain, moisture, etc.), dust and pests.
- You must route the various electrical cables through protective tubes, to protect them against mechanical exertions, essentially on

- the power supply cable. Please note that all the cables must enter the control board from the bottom.
- If the automatism is to be installed at a height of more than 2,5m from the ground or other level of access, the minimum safety and health requirements for the use of work equipment workers at the work of Directive 2009/104/CE of European Parliament and of the Council of 16 September 2009.
- Attach the permanent label for the manual release as close as possible to the release mechanism.
- Disconnect means, such as a switch or circuit breaker on the electrical panel, must be provided on the product's fixed power supply leads in accordance with the installation rules.
- If the product to be installed requires power supply of 230Vac or 110Vac, ensure that connection is to an electrical panel with ground connection.
- The product is only powered by low voltage safety with control board (only at 24V motors).
- Parts/products weighing more than 20 kg must be handled with special care due to the risk of injury. It is recommended to use suitable auxiliary systems for moving or lifting heavy objects.
- Pay special attention to the danger of falling objects or uncontrolled movement of doors/gates during the installation or operation of this product.

WARNINGS FOR USERS

- Keep this manual in a safe place to be consulted whenever necessary.
- If the product has contact with fluids without being prepared, it must immediately disconnect from the power supply to avoid short circuits, and consult a specialized technician.
- Ensure that technician has provided you the product manual and informed you how to handle the product in an emergency.
- If the system requires any repair or modification, unlock the automatism, turn off the power and do not use it until all safety

01. SAFETY INSTRUCTIONS

conditions have been met.

- In the event of tripping of circuits breakers or fuse failure, locate the malfunction and solve it before resetting the circuit breaker or replacing the fuse. If the malfunction is not repairable by consult this manual, contact a technician.
- Keep the operation area of the motorized gate free while the gate in in motion, and do not create strength to the gate movement.
- Do not perform any operation on mechanical elements or hinges if the product is in motion.

RESPONSABILITY

- Supplier disclaims any liability if:
 - Product failure or deformation result from improper installation use or maintenance!
 - Safety norms are not followed in the installation, use and maintenance of the product.
 - Instructions in this manual are not followed.
 - Damaged is caused by unauthorized modifications
 - In these cases, the warranty is voided.

MOTORLINE ELECTROCELOS SA.

Travessa do Sobreiro, nº29
4755-474 Rio Côvo (Santa Eugénia)
Barcelos, Portugal

SYMBOLS LEGEND:



• Important safety notices



• Potentiometer information



• Useful information



• Connectors information



• Programming information



• Buttons information

02. CONTROL BOARD

CHARACTERISTICS

The **MC60** is a control board with built-in radio control system, developed for the automation of sliding, sectional doors, barriers or 24V electromechanical bollard.

• Power Supply	20 Vac
• Flashing light's output	24VDC 4W Max.
• Lock output	12Vdc 3W Max.
• RGB Flashing light's output	24Vdc 100mA Max.
• Motor's output	24Vdc 180W Max.
• Auxiliary accessories output	24V DC 8 W Max.
• Security device output and push button	24V DC
• Working temperature	-25°C to + 55°C
• Incorporated Radio Receiver	433,92 Mhz
• Compatible remote controls	12bits or Rolling Code
• Maximum Memory Capacity	100 (full opening) - 100 (pedestrian opening)
• Control Board Dimensions	130x107 mm
• Fuse F1	16AL 250V
• Fuse F2	1.6AL 250V

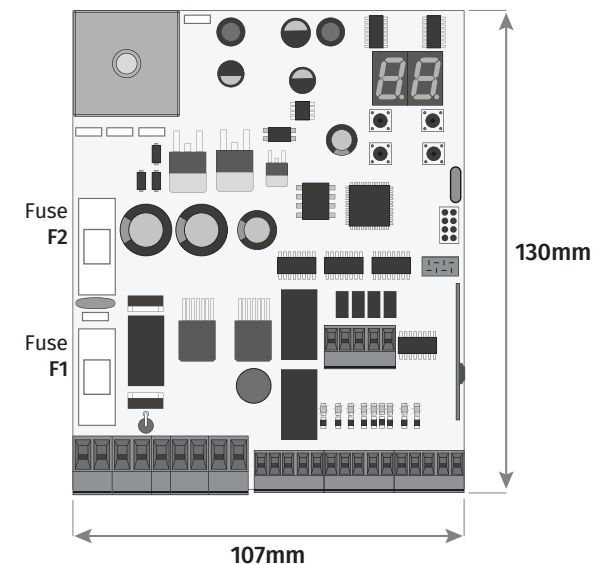

02. CONTROL BOARD

CONNECTORS

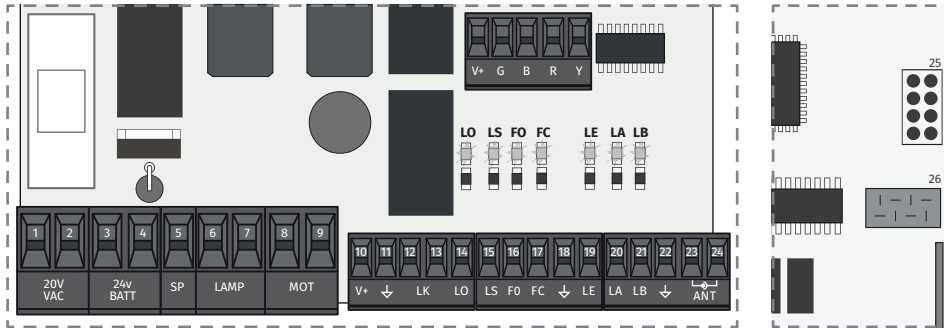

VAC	01 • Power Supply Input - 20Vac 02 • Power Supply Input - 20Vac
BATT	03 • 24Vdc Input for Emergency Battery 24V + max 7Ah 04 • COM Input (Solar Panel or Emergency Battery) 05 • 24Vdc Input for Solar Panel (28V max. 30W)
LAMP	06 • 24Vdc Flashing light's Output (max 4W) 07 • 0V Flashing light's Output
MOT	08 • 24Vdc Motor Output (max 180W) 09 • 24Vdc Motor Output (max 180W)
V+ ↓	10 • 24Vdc output for accessories (max 8W) 11 • 0V output for accessories power supply
LK	12 • 12Vdc Electric Lock Output (max 3W) 13 • 0V Electric Lock Output
LO	14 • Total Opening Input (NO)
LS	15 • Pedestrian Opening Input (NO)
FO	16 • Opening limit-switch input
FC	17 • Closing limit-switch input
↓	18 • Common
LE	19 • Photocells input (NC)
LA	20 • NC input for photocells / 8.2kOhm safety edge
LB	21 • NC input
↓	22 • Common
ANT	23 • Antenna hot pole input 24 • Antenna mass input
LINK	25 • Type-C input for MCONNECT LINK connection
	26 • Special connector for encoder (unused)

02. CONTROL BOARD

BUTTONS AND LEDs

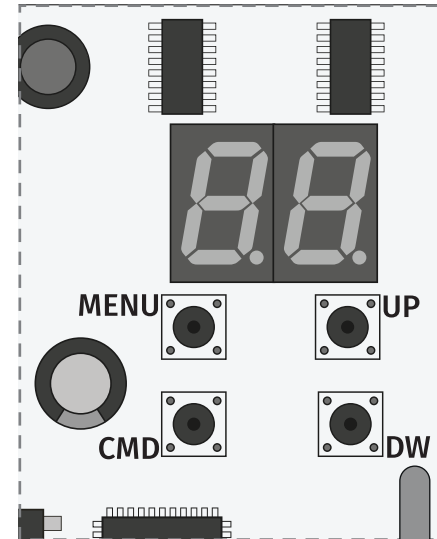

MENU • Access the Menu
CMD • Remote controls programming
UP • Navigate through menus/values
DW • Navigate through menus/values

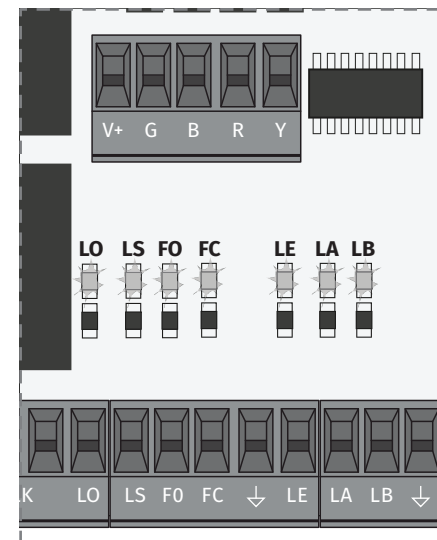

LO • LED ON when total opening input is active
LS • LED on when the pedestrian opening input is active
FO • LED OFF when the opening limit switch is active
FC • LED OFF when closing limit switch is active
LE • LED OFF when the signal from the photocells is interrupted
LA • LED OFF when the signal from the photocells is interrupted
LB • LED OFF when the button is active
BT • LED ON when the battery turned on backwards
VDD • LED ON when power is supplied to the microcontroller

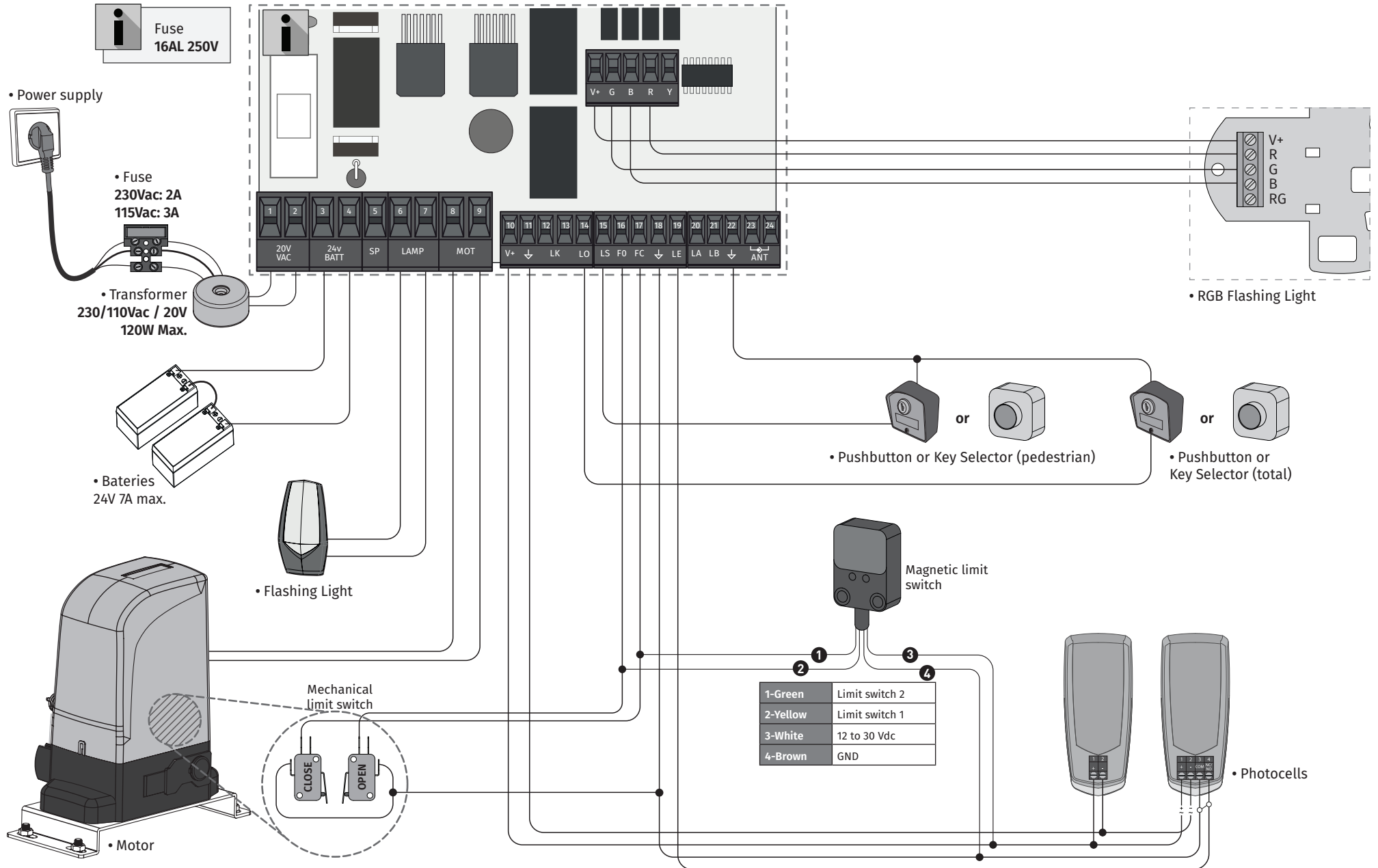

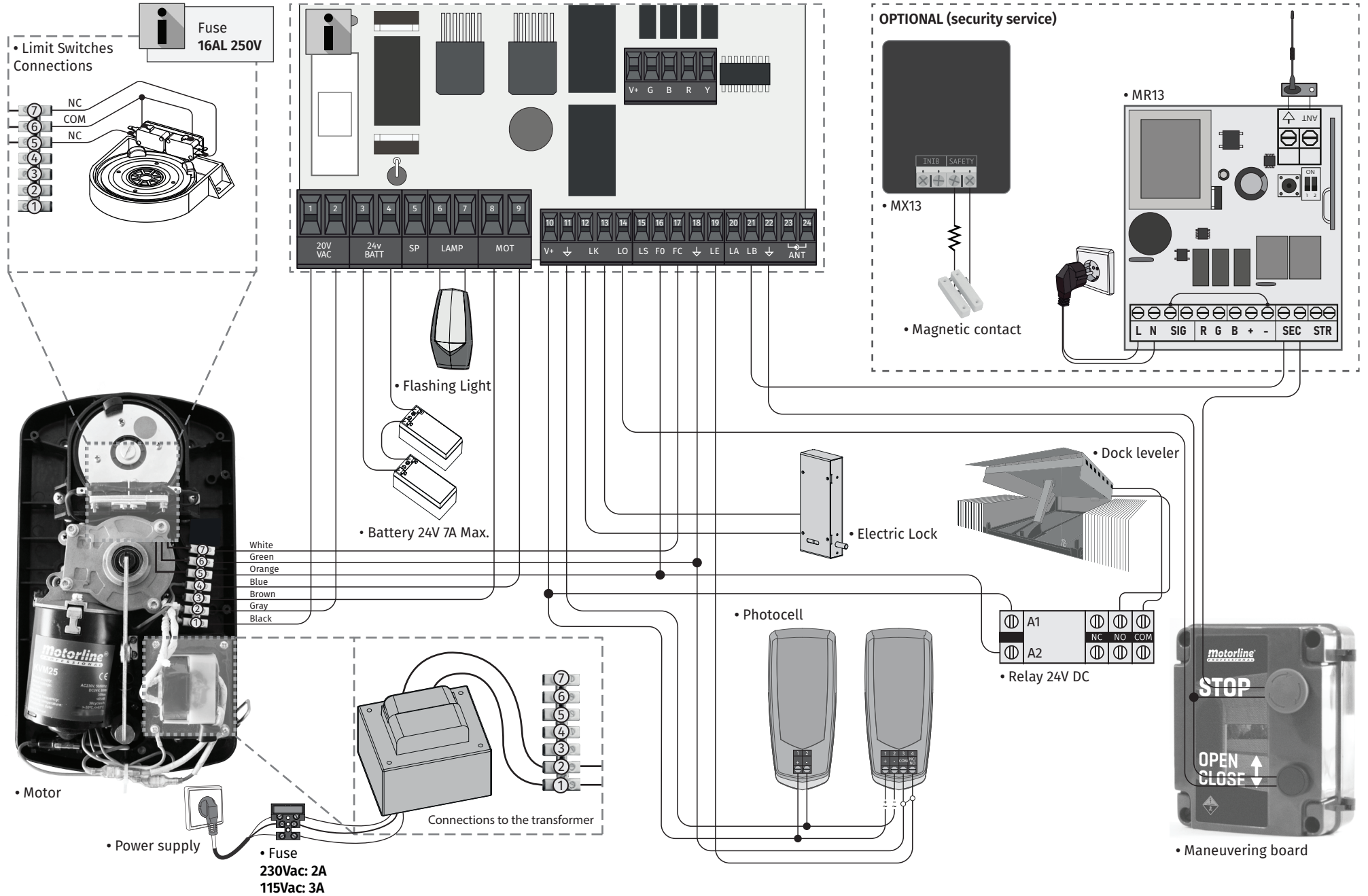

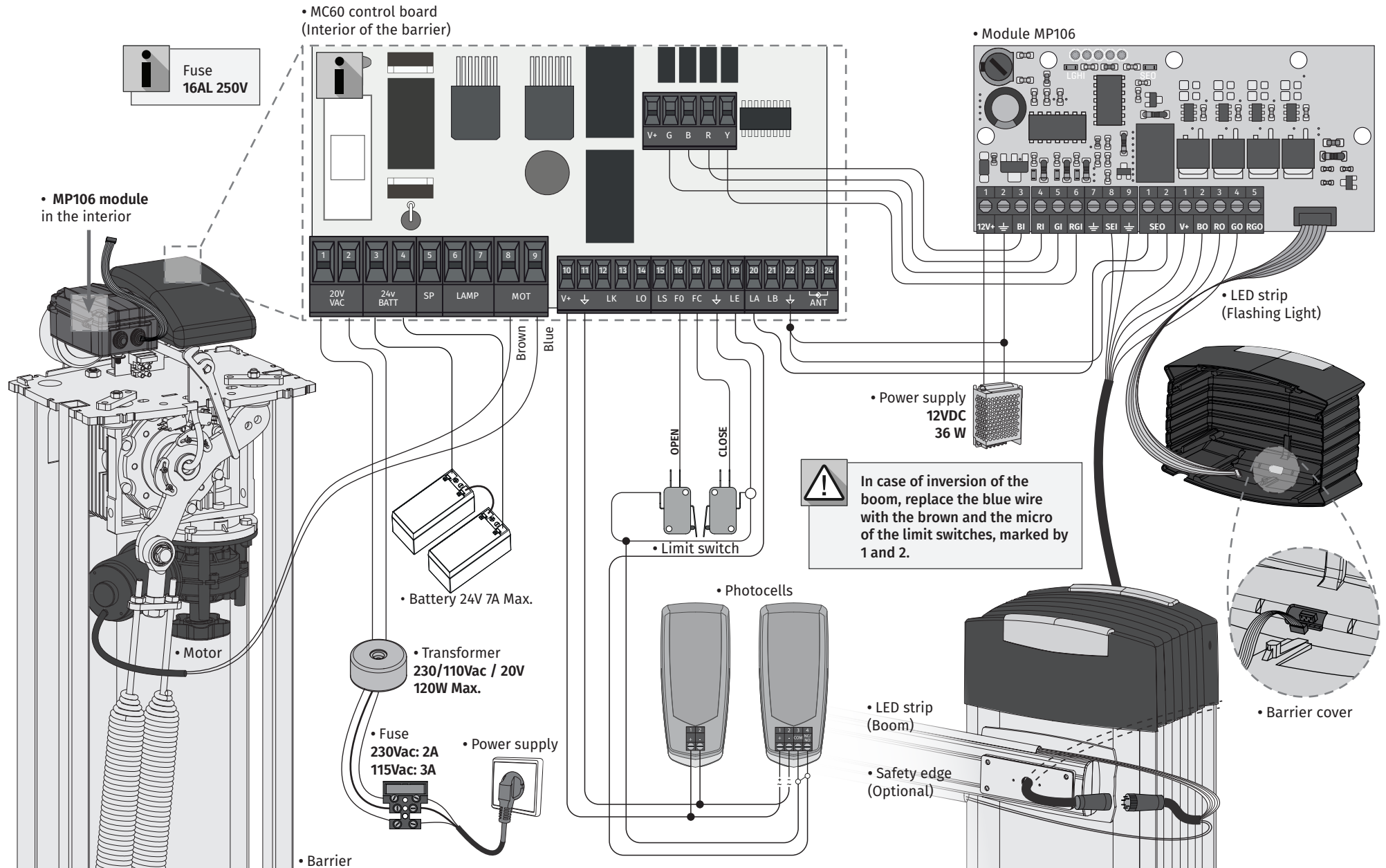

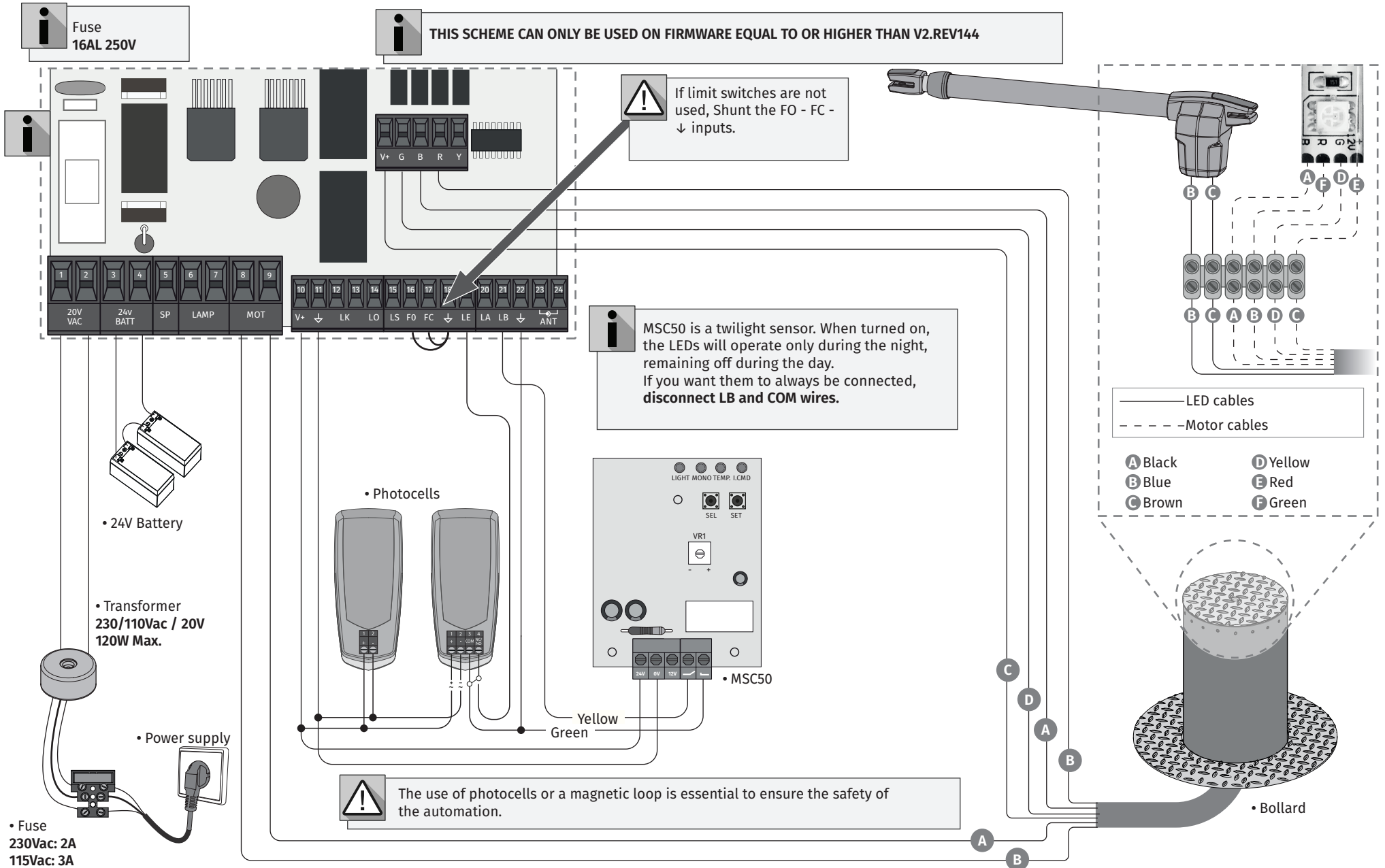

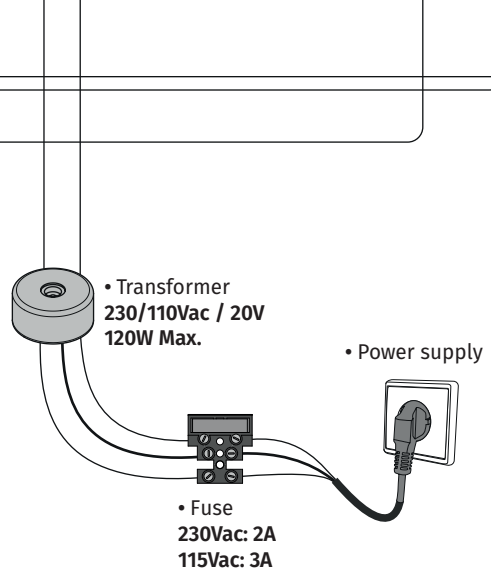
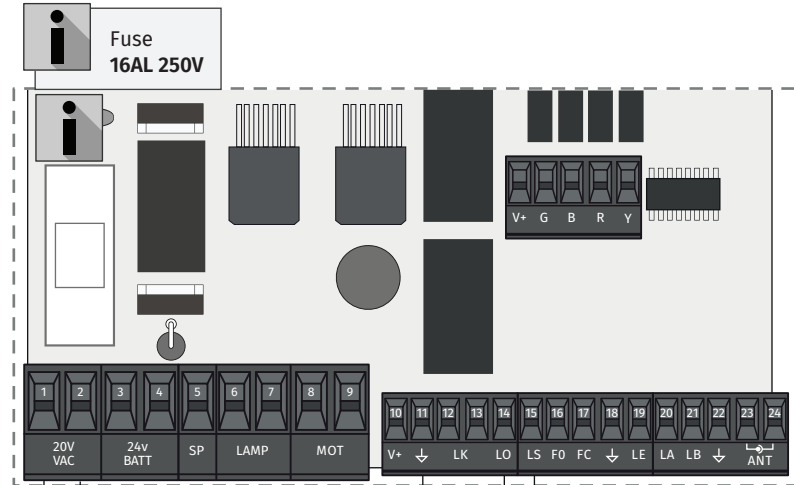
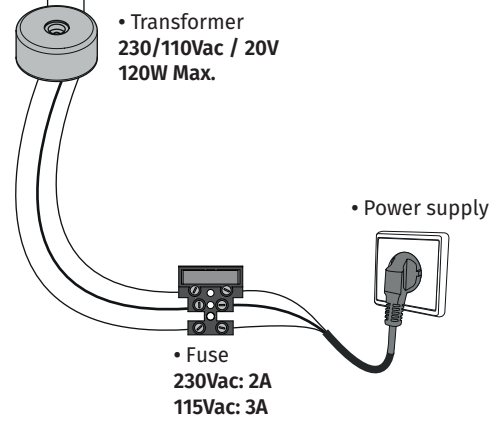
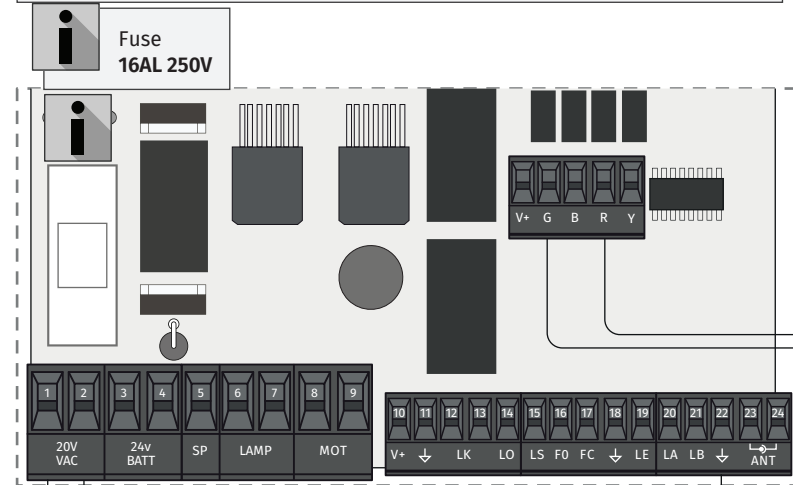

! To use this mode, select the function at P0 (page 16A).
The values are updated automatically.

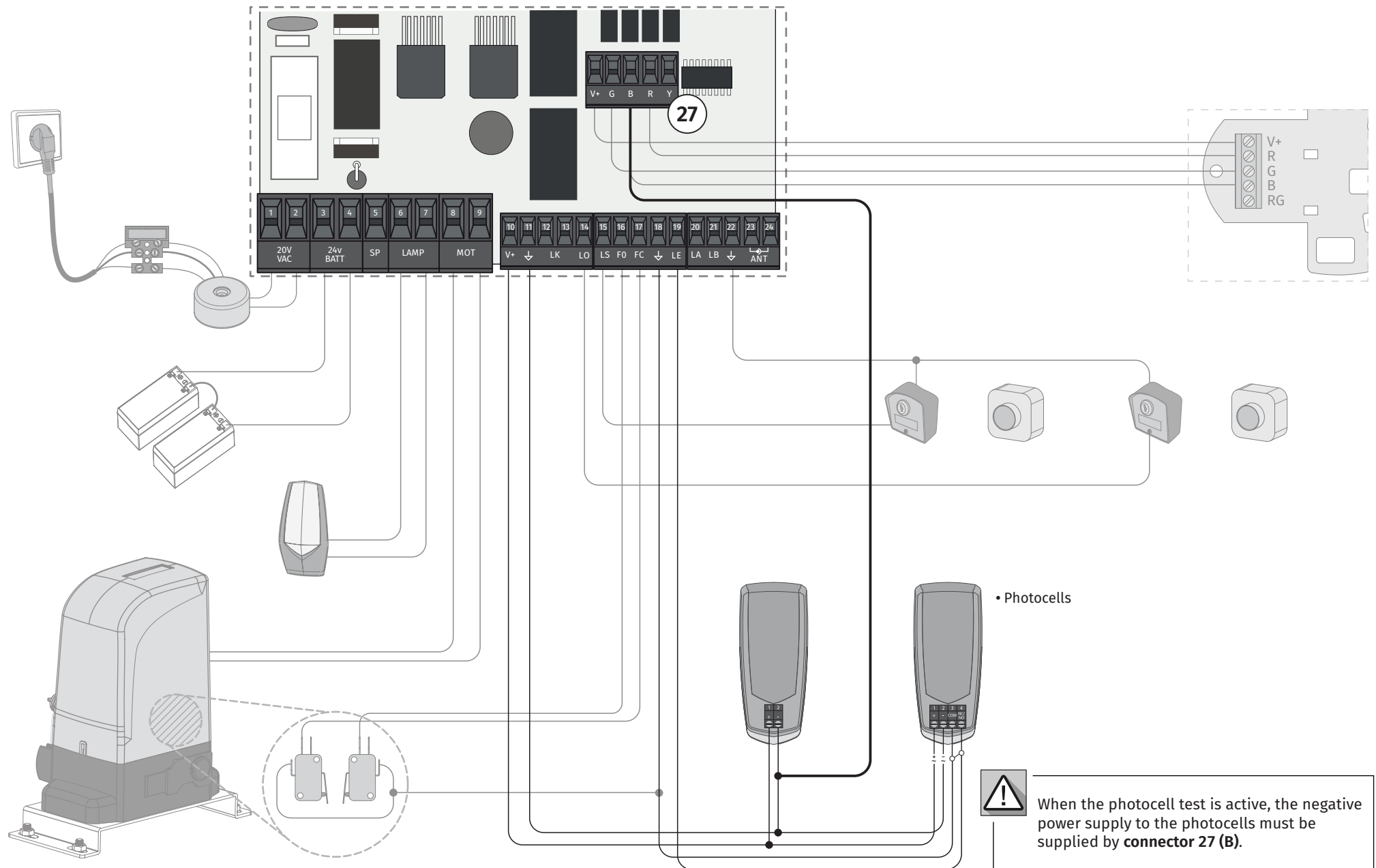



 When the photocell test is active, the negative power supply to the photocells must be supplied by connector 27 (B).



Update the control board firmware if you don't have the latest version. Use the **MCONNECT LINK** to complete the update quickly and securely.

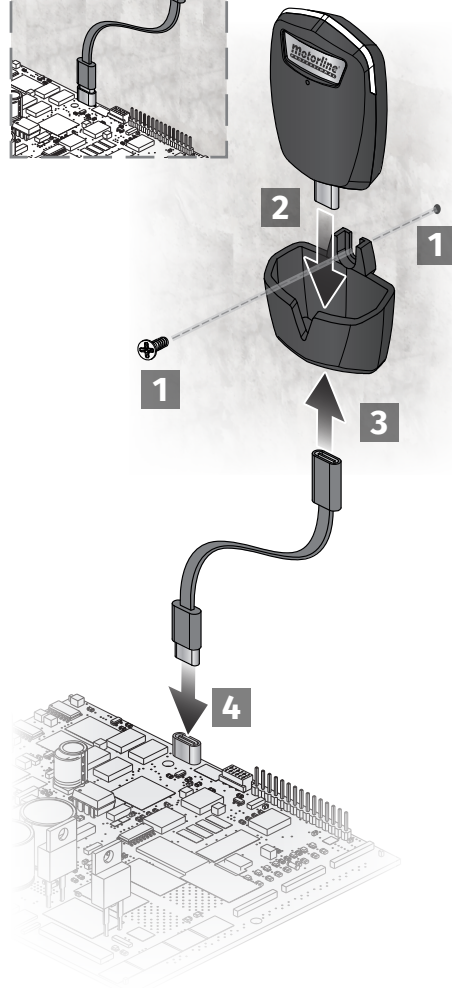
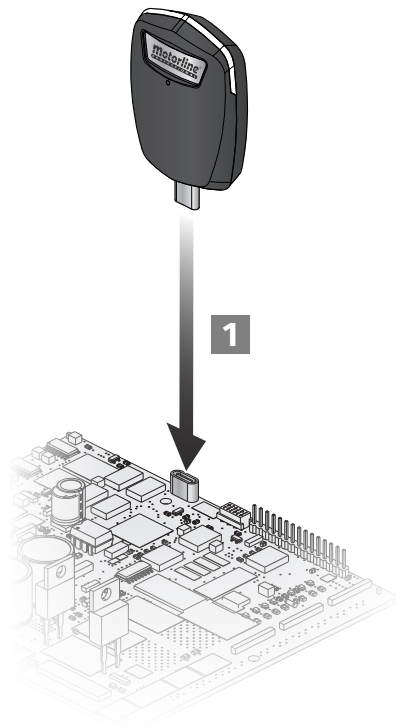
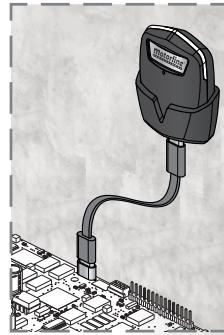
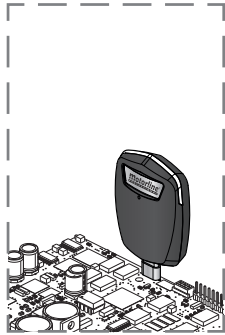

The installation process assumes that the gate already has mechanical or electrical limit switches installed. For more information read the motor's manual.

- 01 • Connect all accessories according to the connections diagram.
- 02 • Connect the control board to a 20V power supply
- 03 • Check if the gate movement is the same as shown on the display:

00

CLOSE

00

OPEN



If the display does not match the movement of the gate, switch off the power supply control board and change the wires of Motor (8 and 9) and check the direction of the limit switches.

- 04 • Make a manual course programming - menu **P0** (page 16A).
- 05 • If necessary, adjust the slowdown time of the gate at opening and closing - menu **P1** (page 16B).
- 06 • Adjust motor force and sensitivity - menu **P2** (page 16B).
- 07 • Make a manual programming of the course again - menu **P0** (page 16A).
- 08 • Enable or disable the use of Photocells in menu **P5** and **P6** (page 17B and 18A).
- 09 • Program a remote control (page 14A).

The control board is now fully configured!

Check the pages of the menu programming if you want to configure other features of the Control board.

SU

Programming a remote control for full opening

SP

Programming a remote control for pedestrian opening

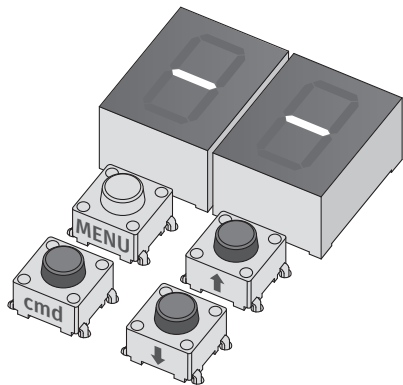

REMOTE CONTROL PROGRAMMING

- 01 • Press the **cmd** button for 1 sec.
- 02 • Select the function where you want to program the remote controls (SU and SP) using ↓ ↑.
- 03 • Press **cmd** once to confirm the function (SU or SP).
- 04 • The first free position appears.
- 05 • Press the remote control button you want to program.
The display will blink and move to the next free location.

DELETE REMOTE CONTROLS

- 01 • Press the **cmd** button for 1 sec.
- 02 • Select the function (SU or SP) using ↓ ↑.
- 03 • Press **cmd** once to confirm the function (SU or SP).
- 04 • Use ↓ ↑ to select the remote control location you want to delete.
- 05 • Press **cmd** for 3sec. and the position is empty.
The display will flash and the position will be available.

DELETE ALL THE REMOTE CONTROLS

- 01 • Press the **cmd** button for 5 sec.
- 02 • The display will show **dL**, confirming that all remote controls have been deleted.



- Whenever you store or delete a remote control, the display will flash and show the next position. You can add or delete remote controls without go back to point 01.
- If you do not press any button for 20 seconds the control board will return to standby.



We can only go into programming with the gate electrically stopped.

The functions of the control board are divided into 2 areas:

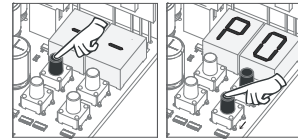

"P" MENU

- 1 • To access the P menu press the MENU button for 2 sec.
- 2 • Use ↓ ↑ to navigate through the menus.
- 3 • Press MENU when you want to confirm access to a menu.
- 4 • Press ↓ ↑ simultaneously to exit programming.

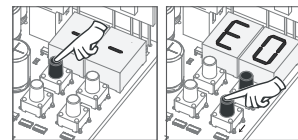
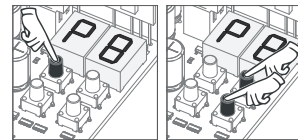

"E" MENU

- 1 • To access the E menu press the MENU button for 10 sec.
- 2 • Use ↓ ↑ to navigate through the menus.
- 3 • Press MENU when you want to confirm access to a menu.
- 4 • Press ↓ ↑ simultaneously to exit programming.

MENU	SUB-MENU	SC	SE	BR	PL
P1	PB	0	0	25	30
P1	PE	0	0	25	30
P2	FD	5	5	9	5
P2	FE	5	5	9	5
P2	FS	5	5	7	5
P2	FE	5	5	7	5
P7	-	1	1	2	2
E0	LB	0	1	0	2
E5	EL	0	1	0	0
E6	So	5	5	2	5
E6	Sc	5	5	1	5

04. INSTALLATION

FUNCTIONS MENU "P"

MENU	FUNCTION	MIN.	MAX.	STATE	FACTORY VALUE	PAGE
P0	Course Programming	-	-	AR Automatic Programming	sc	16A
				AR Manual Programming		
	SE Sliding doors					
	SE Sectional doors					
	BR Electromechanical barriers					
System type	Master/Slave	00 Master	0			
		01 Slave				
P1	Slowdown time adjustment	0s	9.9s	AR Opening slowdown dF Closing slowdown	See table p.14B	16
P2	Force and sensitivity adjustment	0	9	Fa Force Adjustment in Opening	See table p.14B	16B
				Fc Force Adjustment in Closing		
				F5 Sensitivity adjustment		
				Fr Slowdown sensitivity adjustment		
P3	Pedestrian Course time	0s	99s	Time setting in pedestrian mode	10s	17A
P4	Pause time	0s	99s	RF Total pause time adjustment	0s	17A
				RP Pedestrian pause time adjustment		
P5	Photocells 1 programming	-	-	LE 00 Disables photocells 01 Active photocells	00	17B
				HC 00 Photocells in opening 01 Photocells in closing	01	
				HL 00 Invert 01 STOP 02 Invert 2 sec. and Stop	00	
				Sc 00 Deactivates photocell test 01 Activates photocell test	00	
P6	Photocells 2 programming	-	-	LR 00 Disables photocells 01 Active photocells	00	18A
				HC 00 Photocells in opening 01 Photocells in closing	00	
				HL 00 Invert 01 STOP 02 Invert 2 sec. and Stop 03 Reverses when closing, stops and reverses for 2 sec. when opening	01	
				HR 00 Disables safety edge input 01 Activates safety edge input	00	
				Sc 00 Deactivates photocell test 01 Activates photocell test	00	
P7	Operating logic	-	-	00 Automatic mode 01 Step by step mode 02 Condominium mode	01	18A
P8	Flashing light	-	-	00 Flashing (opening and closing) 01 Step by step mode 02 Courtesy light	00	19B
P9	Distance programming	-	-	00 Distance PGM OFF 01 Distance PGM ON	00	19B

04. INSTALLATION

FUNCTIONS MENU "E"

MENU	FUNCTION	MIN.	MAX.	STATE	FACTORY VALUE	PAGE
E0	Human presence	-	-	00 Disables Human presence HP 01 Active at closing 02 Active during opening and closing	00	19A
				PE 00 Disables push buttons mode 01 Activates push buttons mode	00	
				EB 00 Disables emergency device input 01 Activates input for Emergency device 02 Active input for twilight sensor	00	
E1	Soft start	-	-	00 Deactivates Soft start 01 Activates Soft start	01	19B
E2	Courtesy light time / Pre-Flashing lamp	0	99	LE Courtesy light time adjustment	00	19B
				PP Adjustment of Pre-Flashing lamp time	00	
E3	Follow me	-	-	00 Deactivates follow me FL 01 Activates follow me (fully open) 02 Activates follow me (in open or fully open position)	00	20A
				ET Set closing time (sec)		
				1m 9s		
E4	Course time adjustment	1m	4m	OT Opening course time (minutes)	00	20A
				OS Opening course time (seconds)	10s	
				CT Closing course time (minutes)	00	
				CS Closing course time (seconds)	10s	
E5	Brake/Lock/Strokes	-	-	EB 00 Disables electronic brake 01 Active electronic brake	00	20B
				EL 00 Activates lock on opening - 100 msec. 01 Activates lock with polarity 02 Pre-activation of the lock on the opening - 100 msec. 03 Deactivates electromagnet during opening and while it is open with pre-deactivation of 1 sec. before starting to open. Activates the electromagnet during closing and while it is closed.	See table p.14B	
E6	Slowdown Speed	0	9	Sc Adjusting the slowing down at the opening Sc Adjusting the slowing down at the closing	See table p.14B	20B
E7	Manuevers counter	-	-	Shows the number of manuevers	-	21A
E8	Reset - Restore factory settings	-	-	00 Deactivated 01 Reset activated	00	21B
E9	RGB Output	-	-	00 Continued output 01 Intermittent output	00	21B

<p>AU</p>	<p>Automatic course programming This menu allows you to automatic motor programming and slowdown.</p>  <p>To cancel the programming press the UP and DOWN buttons simultaneously. You can use the remote control instead of the MENU button.</p>	<p>Automatic programming: 01 • Press MENU for 1 sec. until it appears P0. 02 • Press MENU once until it appears AU. 03 • Press MENU to start automatic programming. The following maneuvers will be carried out: a • Closes in slowdown (if it's open). b • Opens in slowdown. c • Closes in slowdown. d • Opens at normal speed. e • Closes at normal speed.</p>												
<p>PA</p>	<p>Manual course programming This menu allows manually program the motor and slow down.</p>	<p>Manual programming: 01 • Press MENU for 1 sec. until it appears P0. 02 • Press MENU once until it appears AU. 03 • Press UP until it appears PA. 04 • Press MENU to start programming the opening time. 05 • Press MENU to start programming the slowdown time at the opening. 06 • Press MENU to start programming the closing time. 07 • Press MENU to start programming the slowdown time at closing. 08 • Press MENU to finish programming.</p>												
<p>SY</p>	<p>System type This menu allows you to program the type of system with which the control board will work.</p>	<table border="1"> <tr> <td data-bbox="421 719 488 839"> <p>SE</p> </td> <td data-bbox="488 719 831 839"> <p>Sliding gates: Emergency device deactivated Deactivate Push button function Opening ramp time at 0 Closing ramp time at 0</p> </td> <td data-bbox="831 719 1048 839"></td> </tr> <tr> <td data-bbox="421 839 488 983"> <p>SE</p> </td> <td data-bbox="488 839 831 983"> <p>Sectional doors: Emergency device activated Disables func. pushbutton Ramp time at opening to 0 Ramp time at closing to 0 Activates lock with polarity</p> </td> <td data-bbox="831 839 1048 983"> <p>Programming system type: 01 • Press MENU for 1 sec. until it appears P0. 02 • Press MENU once until it appears AU. 03 • Press UP until it appears SY. 04 • Press MENU to select one of the systems.</p> </td> </tr> <tr> <td data-bbox="421 983 488 1126"> <p>BR</p> </td> <td data-bbox="488 983 831 1126"> <p>Electromechanical barriers: Emergency device disabled Disables func. pushbutton Ramp time at opening to 25 Ramp time at closing to 25 Activates lock on opening</p> </td> <td data-bbox="831 983 1048 1126"></td> </tr> <tr> <td data-bbox="421 1126 488 1230"> <p>PB</p> </td> <td data-bbox="488 1126 831 1230"> <p>Bollard: Deactivate Push button function Opening ramp time at 30 Closing ramp time at 30</p> </td> <td data-bbox="831 1126 1048 1230"></td> </tr> </table>	<p>SE</p>	<p>Sliding gates: Emergency device deactivated Deactivate Push button function Opening ramp time at 0 Closing ramp time at 0</p>		<p>SE</p>	<p>Sectional doors: Emergency device activated Disables func. pushbutton Ramp time at opening to 0 Ramp time at closing to 0 Activates lock with polarity</p>	<p>Programming system type: 01 • Press MENU for 1 sec. until it appears P0. 02 • Press MENU once until it appears AU. 03 • Press UP until it appears SY. 04 • Press MENU to select one of the systems.</p>	<p>BR</p>	<p>Electromechanical barriers: Emergency device disabled Disables func. pushbutton Ramp time at opening to 25 Ramp time at closing to 25 Activates lock on opening</p>		<p>PB</p>	<p>Bollard: Deactivate Push button function Opening ramp time at 30 Closing ramp time at 30</p>	
<p>SE</p>	<p>Sliding gates: Emergency device deactivated Deactivate Push button function Opening ramp time at 0 Closing ramp time at 0</p>													
<p>SE</p>	<p>Sectional doors: Emergency device activated Disables func. pushbutton Ramp time at opening to 0 Ramp time at closing to 0 Activates lock with polarity</p>	<p>Programming system type: 01 • Press MENU for 1 sec. until it appears P0. 02 • Press MENU once until it appears AU. 03 • Press UP until it appears SY. 04 • Press MENU to select one of the systems.</p>												
<p>BR</p>	<p>Electromechanical barriers: Emergency device disabled Disables func. pushbutton Ramp time at opening to 25 Ramp time at closing to 25 Activates lock on opening</p>													
<p>PB</p>	<p>Bollard: Deactivate Push button function Opening ramp time at 30 Closing ramp time at 30</p>													
<p>MS</p>	<p>Master/Slave Communication model for hardware devices where one device has one-way control over another device.</p>	<p>Programming Master/Slave: 01 • Press MENU for 1 sec. until it appears P0. 02 • Press MENU until it appears MS. 03 • Select 00 or 01. 04 • Press MENU to confirm a function.</p> <table border="1"> <tr> <td data-bbox="421 1230 488 1302"> <p>00</p> </td> <td data-bbox="488 1230 831 1302"> <p>Master Controls the main functions of the Slave</p> </td> <td data-bbox="831 1230 1048 1302"></td> </tr> <tr> <td data-bbox="421 1302 488 1453"> <p>01</p> </td> <td data-bbox="488 1302 831 1453"> <p>Slave It is controlled by the Master</p> </td> <td data-bbox="831 1302 1048 1453"></td> </tr> </table>	<p>00</p>	<p>Master Controls the main functions of the Slave</p>		<p>01</p>	<p>Slave It is controlled by the Master</p>							
<p>00</p>	<p>Master Controls the main functions of the Slave</p>													
<p>01</p>	<p>Slave It is controlled by the Master</p>													

This menu allows to set the slowdown time at opening and closing.

<p>DA</p> <p>Opening slowdown Allows to set the time that the gate will act with slowdown in the opening. (Default value 03)</p>	<p>DE</p> <p>Closing slowdown Allows to set the time that the gate will act with slowdown in the closing. (Default value 03)</p>
<p>PO</p> <p>Time ramp at the opening Allows to set the slowdown ramp time at the opening. (Default value SC=00; SE=00; BR=25; PL=30)</p>	<p>PC</p> <p>Time ramp at the closing Allows to set the slowdown ramp time at the closing. (Default value SC=00; SE=00; BR=25; PL=30)</p>



01 • Press MENU for 2 sec. until appears **P0**.
02 • Use UP to change to **PA**.
03 • Press MENU until appears **DA**. Use UP or DW to navigate the parameters.
04 • Press MENU to edit the chosen parameter value.
05 • The factory set time appears. Use UP and DW to change the value.
06 • Press MENU to save the new value.



A very low value in this parameter F0 or Fc, can cause the motor not to have enough torque to move the gate, or FS or Fs too high.

<p>F0</p> <p>Opening force adjustment Allows to set the force that is injected into the opening when the motor moves at normal speed.</p>	<p>Fc</p> <p>Closing force adjustment Allows to set the force that is injected into the closing when the motor moves at normal speed.</p>	<p>FS</p> <p>Sensitivity adjustment Allows to adjust the sensitivity of the motor when detecting obstacles. The higher the sensitivity, the less effort it will take to detect any obstacle and reverse direction.</p>	<p>Fs</p> <p>Slowdown sensitivity adjustment Allows to adjust the sensitivity of the motor when detecting obstacles. The higher the sensitivity, the less effort it will take to detect any obstacle and reverse direction.</p>
<p>min. 0 max. 99 (Default value: SC=05; SE=05; BR=09; PL=05)</p>	<p>min. 0 max. 99 (Default value: SC=05; SE=05; BR=09; PL=05)</p>	<p>min. 0 max. 99 (Default value: SC=05; SE=05; BR=07; PL=05)</p>	<p>min. 0 max. 99 (Default value: SC=00; SE=00; BR=07; PL=05)</p>

- 01 • Press MENU for 2 sec. until appears *P0*.
- 02 • Use UP until appears *P2*.
- 03 • Press MENU will appear *F0*.
- 04 • Press MENU to edit the value.
- 05 • The factory set time appears. Use UP and DW to change the value.
- 06 • Press MENU to save the new value.

The pedestrian mode allows the gate to be opened for the passage of people, without it needing to open in its entirety. In this function you can program the time you want the gate to open.



For pedestrian mode to work, the minimum working time must be 1 second, and 0 disables the pedestrian.



- 01 • Press MENU for 2 sec. until appears *P0*.
- 02 • Use UP until appears *P3*.
- 03 • Press MENU. The factory set time appears.
- 04 • Use UP and DW to change the value.
- 05 • Press MENU to save the new value.

*AF***Pause time adjustment for automatic closing**

Allows you to set the waiting time for the gate from when it finishes fully opening until it starts to close.

*AP***Pause time adjustment for automatic closing in pedestrian closing**

Allows you to set the waiting time since finish the pedestrian opening until it starts to close.



When the values are at zero, there is no automatic closing.

- 01 • Press MENU for 2 sec. until appears *P0*.
- 02 • Use UP to change to *P4*.
- 03 • Press MENU until appears *AF*. Use UP or DW to navigate the parameters.
- 04 • Press MENU to edit the chosen parameter value.
- 05 • The factory set time appears. Use UP and DW to change the value.
- 06 • Press MENU to save the new value.

Allows to program the security behavior LE (photocell 1).

<i>LE</i>	00 (disable photocells) 01 (activate photocells) Enable or disable security entry.	Default value (00)
<i>HE</i>	00 (photocells in opening) 01 (photocells in closing) This menu can only be changed when the LE menu is active. Allows you to define whether this security will act on the opening or closing of the gate.	Default value (01)
<i>HB</i>	00 (the gate is reversed) 01 (gate stops and resumes 5 sec after security is disabled) 02 (gate reverses for 2 sec. and stop) It allows to define the behavior that the gate will have when this security is activated.	Default value (00)
<i>SB</i>	00 (Deactivates photocell test) 01 (Activates photocell test) Allows you to activate or deactivate the photocell test.	Default value (00)

- 01 • Press MENU for 2 sec. until appears *P0*.
- 02 • Use UP until appears *P5*.
- 03 • Press MENU will appear *LE*. Use UP or DW to navigate the parameters.
- 04 • Press MENU to edit the chosen parameter value.
- 05 • The factory set time appears. Use UP and DW to change the value.
- 06 • Press MENU to save the new value.

Allows to program the security behavior LA (photocell 2).

LA	00 (disable photocells)	Default value (00)
	01 (activate photocells) Enable or disable security entry.	
HE	00 (photocells in opening)	Default value (01)
	01 (photocells in closing) This menu can only be changed when the LA menu is active. Allows you to define whether this security will act on the opening or closing of the gate.	
HU	00 (the gate is reversed)	Default value (00)
	01 (gate stops and resumes 5 sec after security is disabled)	
	02 (gate reverses for 2 sec. and stop)	
	03 (the gate reverses when closing, stops and reverses for 2 seconds when opening) Allows to set the behavior that the gate will have when this security is activated.	
HA	00 (disables safety edge)	Default value(00)
	01 (active safety edge)	
SE	00 (Deactivates photocell test)	Default value (00)
	01 (Activates photocell test) Allows you to activate or deactivate the photocell test.	

- 01 • Press MENU for 2 sec. until appears P0.
- 02 • Use UP to change to P6.
- 03 • Press MENU until appears LA. Use UP or DW to navigate the parameters.
- 04 • Press MENU to edit the chosen parameter value.
- 05 • The factory set time appears. Use UP and DW to change the value.
- 06 • Press MENU to save the new value.

This menu allows to set the operating logic of the automation

00	01	02
Automatic Mode Whenever there is an order the movement is reversed.	Step by step mode 1st impulse - OPEN 2nd impulse - STOP 3rd impulse - CLOSE 4th impulse - STOP If it is fully open and timed, it closes.	Condominium Mode Does not respond to orders during opening and pause time.

(Default value: SC=01; SE=01; BR=02; PL=02)

- 01 • Press MENU for 2 sec. until appears P0.
- 02 • Use UP until appears P7.
- 03 • Press MENU will appear 00.
- 04 • Press MENU to edit the value.
- 05 • Use UP and DW to change the value.
- 06 • Press MENU to save the new value.

This menu allows to set the operation mode of the flashing light (LAMP).

00	01	02
Flashing (opening and closing) During the opening/closing movement of the gate, the flashing light will operate intermittently. Opening - flashing 2s Closing - flashing 1s	Step by step mode In the opening and closing movement, the flashing light is permanently ON. When stopped, it remains off.	Courtesy light In the opening and closing movement the flashing light is permanently ON. When in pause time remains ON. When stopped or closed, remains on for the time set in E2.
Default value (00)		

- 01 • Press MENU for 2 sec. until appears P0.
- 02 • Use UP until appears P8.
- 03 • Press MENU will appear 00.
- 04 • Press MENU to edit the value.
- 05 • Use UP and DW to change the value.
- 06 • Press MENU to save the new value.

00	01
Distance PGM OFF	Distance PGM ON

This menu allows to enable or disable the programming of new remote control without directly accessing the control board, using a previously stored remote control (memorize remote controls page 14A).

Default value (00)

- 01 • Press MENU for 2 sec. until appears P0.
- 02 • Use UP until appears P9.
- 03 • Press MENU will appear 00.
- 04 • Press MENU to edit the value.
- 05 • Use UP and DW to change the value.
- 06 • Press MENU to save the new value.

Distance Programming Operation (PGM ON):



• Press the buttons indicated in the image simultaneously for 10 seconds and the flashing light will flash (the 1st free position appears in the display). Each time you store 1 remote control, the control board will exit distance programming. If you want to memorize more remote control, you will always have to repeat the process of pressing the remote controls buttons simultaneously for 10 seconds for each new remote control.

HP	PB		LB									
<p>00 (disables human presence) Whenever a order is sent to the LO input and the motor performs a complete maneuver.</p> <p>Human presence 01 (active at closing) The motor only works if you keep the LS button pressed.</p> <p>Human presence 02 (active during opening and closing) The motor only works if you keep the LO or LS button pressed depending on the desired action.</p> <p> When human presence active, the RF remote controls do not work.</p> <p>(Default value 00)</p>	<p>00 (disables pushbutton mode)</p> <p>01 (active pushbutton mode)</p> <table border="1"> <thead> <tr> <th></th> <th>LS</th> <th>LO</th> </tr> </thead> <tbody> <tr> <td>01 ACTIVE</td> <td>Full closing</td> <td>Full opening</td> </tr> <tr> <td>00 OFF</td> <td>Pedestrian opening</td> <td>Full opening</td> </tr> </tbody> </table>			LS	LO	01 ACTIVE	Full closing	Full opening	00 OFF	Pedestrian opening	Full opening	<p>Allows you to define the way Operation of the LB input</p> <p>00 (disables input to emergency stop device)</p> <p>01 (input for emergency stop device)</p> <p>02 (input for twilight sensor - outputs for LEDs that work at night and remain off during the day). (NOTE: This option is only available in the PL version)</p> <p>(Default value SC=00; SE=01; BR=00; PL=02)</p>
	LS	LO										
01 ACTIVE	Full closing	Full opening										
00 OFF	Pedestrian opening	Full opening										

- 01 • Press MENU for 10 sec. until it appears E0.
- 02 • Press MENU until appears HP. Use UP or DW to navigate the parameters.
- 03 • Press MENU to edit the chosen parameter value.
- 04 • The factory set time appears. Use UP and DW to change the value.
- 05 • Press MENU to save the new value.

00 function disabled
01 function activated

Enables or disables the soft start. With the soft start function activated, at each start of movement the control board will control the motor start, increasing the speed gradually in the first second of operation.

(Default value 01)

- 01 • Press MENU for 10 sec. until it appears E0.
- 02 • Use UP until appears E1.
- 03 • Press MENU will appear 00.
- 04 • Press MENU to edit the value.
- 05 • Use UP and DW to change the value.
- 06 • Press MENU to save the new value.

LE	PE
<p>Allows to adjust the courtesy light time. The courtesy light is activated the set time when the gate is in the closed, opened and stopped position.</p> <p>The E2 menu will only be available if the courtesy light function is activated in the P8 menu option 2 (see page 19B).</p> <p>(Default value 00)</p>	<p>This menu allows you to define the time (from 1 to 99 seconds) that the flashing lamp remains active before the start of each maneuver.</p>
<p>01 • Press MENU for 10 sec. until it appears E0.</p> <p>02 • Use UP until appears E2.</p> <p>03 • Press MENU will appear LE. Use UP or DW to navigate the parameters.</p> <p>04 • Press MENU to edit the value.</p> <p>05 • Use UP and DW to change the value.</p> <p>06 • Press MENU to save the new value.</p>	

FB

00 function disabled**01 function activated after opening**

The control board activates the closing only after completing the opening, based on the time defined in the E7 function

02 function activated during opening

The control board activates the closing after completing the opening, when, during opening, the user/object passes through the photocells, based on the time defined in the E7 function

This menu allows activating the Follow me option.

With this function activated, whenever the safety device detects the passage of a user/object, the control board activates the closing maneuver based on the time selected in this parameter.

(Default value 00)

E7

01 - 09 closing time function

Allows you to define the waiting time between detection and the start of the closing maneuver after the safety device detects the passage of an object/user.

- 01 • Press MENU for 10 sec. until E0 appears.
- 02 • Press MENU until FB appears. Use UP or DW to navigate parameters.
- 03 • Press MENU to edit the value of the chosen parameter.
- 04 • Choose the desired value. Use UP and DW to change the value.
- 05 • Press MENU to save the new value.

Allows to adjust the working time for the opening and closing courses at normal speed

E7	E5	E7	E5
Opening course time at normal speed (minutes)	Opening course time at normal speed (seconds)	Closing course time at normal speed (minutes)	Closing course time at normal speed (seconds)
(Default value 0)	(Default value 10)	(Default value 0)	(Default value 10)

- 01 • Press MENU for 10 sec. until it appears E0.
- 01 • Use UP until appears E4.
- 02 • Press MENU will appear E7. Use UP or DW to navigate the parameters.
- 03 • Press MENU to edit the chosen parameter value.
- 04 • The factory set time appears. Use UP and DW to change the value.
- 05 • Press MENU to save the new value.

Allows you to program the gate's behavior

EB

00 (disables electronic brake) | 01 (activates electronic brake)

Allows you to activate the electronic brake.

Default value (00)

EB

00 (activates lock at opening 100ms)**01 (activates lock whenever moving)****02 (Pre-activation of the lock on the opening - 200 msec.)**

03 (Deactivates electromagnet during opening and while it is open with pre-deactivation of 1 sec. before starting to open. Activates the electromagnet during closing and while it is closed.)

Default value (00)

- 01 • Press MENU for 10 sec. until it appears E0.
- 02 • Use UP until appears E5.
- 03 • Press MENU will appear EB. Use UP or DW to navigate the parameters.
- 04 • Press MENU to edit the chosen parameter value.
- 05 • The factory set time appears. Use UP and DW to change the value.
- 06 • Press MENU to save the new value.

This menu allows you to adjust the slowdown speed.
The higher the level, the faster the slowdown.

SB

Setting of the slowdown speed at the opening

Allows you to adjust the slowdown speed in the motor opening.

SE

Setting of the slowdown speed at the closing

Allows you to adjust the slowdown speed in the motor closing.

min. 0 max. 9
(Default value: SC=05; SE=05; BR=02; PL=05)

min. 0 max. 9
(Default value: SC=05; SE=05; BR=01; PL=05)

- 01 • Press MENU for 10 sec. until it appears E0.
- 02 • Use UP until appears EB.
- 03 • Press MENU will appear SB.
- 04 • Press MENU to edit the value.
- 05 • Use UP and DW to change the value.
- 06 • Press MENU to save the new value.

This menu allows checking how many complete maneuvers were performed by the control board (complete maneuver means opening and closing).



Resetting the control board does not clear the maneuver count.

Example: 130371 maneuvers
13- Hundred thousand / 03- Thousands / 71- Dozens

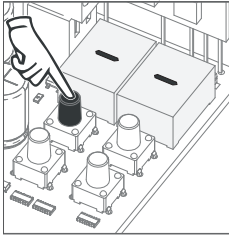

01 • Press MENU for 10 seconds.

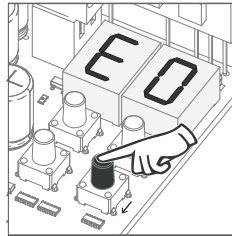

02 • E0 appears. Press UP until appears E7.

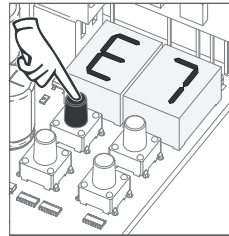

03 • Press MENU.

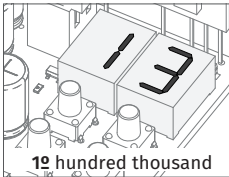

display flashes →

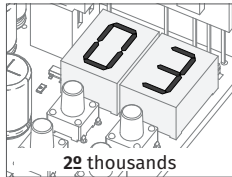

display flashes →

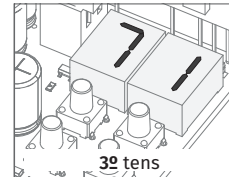

04 • The maneuvers count is displayed in the following order (example: 130 371)

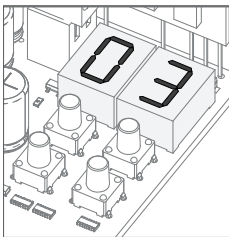

05 • E8 appears.



Resetting the control board does not erase the maneuver count.

00	01
Disabled	Reset enabled
(Default value 00)	

- 01 • Press MENU for 10 sec. until it appears E0.
- 02 • Use UP until appears E8.
- 03 • Press MENU will appear 00.
- 04 • Press MENU to edit the value.
- 05 • Use UP and DW to change the value.
- 06 • Press MENU to save the new value.

00	01
Continuous light	Flashing light
(Default value 00)	

- 01 • Press MENU for 10 sec. until it appears E0.
- 02 • Use UP until appears E9.
- 03 • Press MENU will appear 00.
- 04 • Press MENU to edit the value.
- 05 • Use UP and DW to change the value.
- 06 • Press MENU to save the new value.

MENU	DESCRIPTION	MENU	DESCRIPTION
88	In stop position, fully open	88	All remote controls erased
88	In stop position, intermediate position	00 01 02	Remote control triggered from the indicated position
88	In stop position, fully closed	8E	Obstructed photocell
00	Full opening button pressed	8A	Obstructed photocell
05	Pedestrian opening button pressed	8F	In pause time
0P	Control board performs the opening course	8P	In pedestrian pause time
88	Control board performs the closing course	81	Motor overcurrent detection
F0	End of opening course time	86	Emergency device activated
88	End of closing course time	8A	Safety edge pressed
0U	Full memory	8P	Control board in Pre-Flashing lamp
58	Photocell test failed		

Anomaly	Procedure	Behavior	Procedure II	Discovering the origin of the problem			
• Motor doesn't work.	• Make sure you have power supply connected to the automatism and if it is working.	• Still not working.	• Consult a MOTORLINE technician.	<p>1 • Open control board and check if it has power supply.</p> <p>2 • Check input fuses of the control board.</p>	<p>3 • Disconnect motor from control board and test it by connecting directly to 12/24V power supply in order to find out if it has the problems.</p>	<p>4 • If the motor works, the problem is on the control board. Pull it out and send it to our MOTORLINE technical services for diagnosis.</p>	<p>5 • If the motor doesn't work, remove from installation site and send it to our MOTORLINE technical services for diagnosis.</p>
• Motor doesn't move but makes noise.	• Unlock the motor and move the gate/barrier/automatic bollard by hand to check for mechanical problems.	• Encountered problems?	• Consult a qualified technician in gate/barrier/automatic bollard.	Check all motion axis and associated motion systems related with the gate/barrier/automatic bollard (wheels,	racks, etc) to find out what is the problem.		
		• The gate/barrier/automatic bollard moves easily?	• Consult a MOTORLINE technician.	<p>1 • If the motor works, the problem is with control board. Pull it out and send it to our MOTORLINE technical services for</p>	<p>diagnosis.</p> <p>2 • If the motor doesn't work, remove it from installation</p>	<p>site and send it to our MOTORLINE technical services for diagnosis.</p>	
• Motor opens but doesn't close.	• Unlock the motor and move the gate/barrier/automatic bollard by hand to closed position. Block the motor again. Turn off power supply for 5 seconds, and reconnect. Send order to open using remote control.	• The gate/barrier/automatic bollard opened but didn't close again.	<p>1 • Check if there is any obstacle in front of the photocells.</p> <p>2 • Check if any of the control devices (Key Selector, Pushbutton, Video Intercom, etc.) are stucked and sending permanent signal to control board.</p> <p>3 • Consult a MOTORLINE technician.</p>	<p>All control boards MOTORLINE have LEDs that easily allow to conclude which devices are with anomalies. All safety device (DS) LEDs in normal situations remain ON. All "START" circuits LEDs in normal situations remain Off.</p> <p>If LEDs devices are not all On, there is some security systems malfunction (photocells, safety edges). If "START" LEDs are on, there is some command issuing device emitting a permanent signal.</p>	<p>A) SECURITY SYSTEMS:</p> <p>1 • Close with a shunt all safety systems on the control board. If the automated system starts working normally check for the problematic device.</p> <p>2 • Remove one shunt at a time until you find the malfunction device.</p> <p>3 • Replace it for a functional device and check if the motor works correctly with all the other devices. If you find another one defective, follow the same steps until you find all the problems.</p>	<p>B) START SYSTEMS:</p> <p>1 • Disconnect all wires connected to the START connector (LO and LS).</p> <p>2 • If the LED turned OFF, try reconnecting one device at a time until you find the defective device.</p>	<p>NOTE:</p> <p>In case procedures described in sections A) and B) don't result, remove control board and send it to our MOTORLINE technical services for diagnosis.</p>
• Motor doesn't make complete course.	• Unlock the motor and move the gate/barrier/automatic bollard by hand to check for mechanical problems.	• Encountered problems?	• Consult a qualified technician in gate/barrier/automatic bollard.	Check all motion axis and associated motion systems related with the gate/barrier/automatic bollard (wheels,	racks, etc) to find out what is the problem.		
		• The gate/barrier/automatic bollard moves easily?	• Consult a MOTORLINE technician.	<p>1 • If the motor doesn't work, remove it from installation site and send it to our MOTORLINE technical services for diagnosis.</p> <p>2 • If the motor works well and move gate at full force during the entire course, the problem is with control board. Set force using trimmer on the board. Make a new working time programming, giving sufficient</p>	<p>time for opening and closing with appropriate force.</p> <p>3 • If this doesn't work, remove control board and send it to MOTORLINE technical services.</p> <p>NOTE:</p> <p>Setting force of the control board should be sufficient to make the gate open and close without stopping, but should stop and</p>	<p>invert with a little effort from a person. In case of safety systems failure, the gate shall never cause physical damaged to obstacles (vehicles, people, etc.).</p>	