

MC80

USER / INSTALLER MANUAL

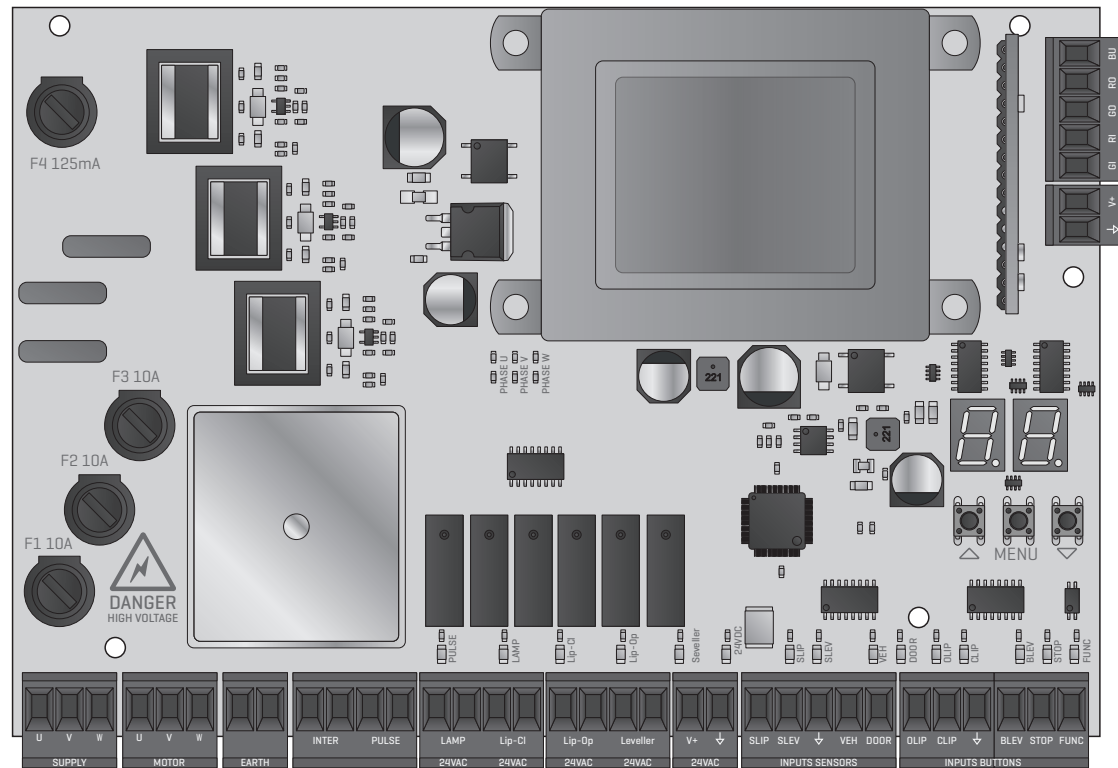







00. CONTENT

INDEX

01. SAFETY INSTRUCTIONS	1B
02. CONTROL BOARD	
TECHNICAL CHARACTERISTICS	4A
CONNECTOR LEGEND	4B
OPERATING MODE	5B
WITH HINGED LIP WITHOUT AUTOMATIC RETURN	6A
WITH HINGED LIP WITH AUTOMATIC RETURN	6A
WITH EXTENDABLE LIP WITH AUTOMATIC RETURN	6B
FREE	6B
03. PROGRAM	
M FUNCTIONS	7A
04. DISPLAY	
DISPLAY INDICATIONS	10B
05. CONNECTION DIAGRAM	
WITH HINGED LIP WITHOUT AUTOMATIC RETURN	11
WITH HINGED LIP WITH AUTOMATIC RETURN	12
WITH EXTENDABLE LIP WITH AUTOMATIC RETURN	13

01. SAFETY INSTRUCTIONS

	This product is certified in accordance with European Community (EC) safety standards.
	This product complies with Directive 2011/65/EU of the European Parliament and of the Council, of 8 June 2011, on the restriction of the use of certain hazardous substances in electrical and electronic equipment and with Delegated Directive (EU) 2015/863 from Commission.
	(Applicable in countries with recycling systems). This marking on the product or literature indicates that the product and electronic accessories (eg. Charger, USB cable, electronic material, controls, etc.) should not be disposed of as other household waste at the end of its useful life. To avoid possible harm to the environment or human health resulting from the uncontrolled disposal of waste, separate these items from other types of waste and recycle them responsibly to promote the sustainable reuse of material resources. Home users should contact the dealer where they purchased this product or the National Environment Agency for details on where and how they can take these items for environmentally safe recycling. Business users should contact their vendor and check the terms and conditions of the purchase agreement. This product and its electronic accessories should not be mixed with other commercial waste.
	This marking indicates that batteries should not be discarded like other household waste at the end of their useful life. Batteries must be delivered to selective collection points for recycling.
	The different types of packaging (cardboard, plastic, etc.) must be subject to selective collection for recycling. Separate packaging and recycle it responsibly.
	This marking indicates that the product and electronic accessories (eg. charger, USB cable, electronic material, controls, etc.) are susceptible to electric shock by direct or indirect contact with electricity. Be cautious when handling the product and observe all safety procedures in this manual.

01. SAFETY INSTRUCTIONS

GENERAL WARNINGS

- This manual contains very important safety and usage information. Read all instructions carefully before beginning the installation/usage procedures and keep this manual in a safe place that it can be consulted whenever necessary.
- This product is intended for use only as described in this manual. Any other enforcement or operation that is not mentioned is expressly prohibited, as it may damage the product and put people at risk causing serious injuries.
- This manual is intended firstly for specialized technicians, and does not invalidate the user's responsibility to read the "User Norms" section in order to ensure the correct functioning of the product.
- The installation and repair of this product may be done by qualified and specialized technicians, to assure every procedure are carried out in accordance with applicable rules and norms. Nonprofessional and inexperienced users are expressly prohibited of taking any action, unless explicitly requested by specialized technicians to do so.
- Installations must be frequently inspected for unbalance and the wear signals of the cables, springs, hinges, wheels, supports and other mechanical assembly parts.
- Do not use the product if it is necessary repair or adjustment is required.
- When performing maintenance, cleaning and replacement of parts, the product must be disconnected from power supply. Also including any operation that requires opening the product cover.
- The use, cleaning and maintenance of this product may be carried out by any persons aged eight years old and over and persons whose physical, sensorial or mental capacities are lower, or by persons without any knowledge of the product, provided that these are supervision and instructions given by persons with experienced in terms of usage of the product in a safe manner and who understands the risks and dangers involved.

- Children shouldn't play with the product or opening devices to avoid the motorized door or gate from being triggered involuntarily.
- If the power cable is damaged, it must be replaced by the manufacturer, after-sales service or similarly qualified personnel to avoid danger.
- The device must be disconnected from the electrical network when removing the battery.
- Ensure that blocking is avoided between the actuated part and its fixed parts due to the opening movement of the actuated part.

WARNINGS FOR TECHNICIANS

- Before beginning the installation procedures, make sure that you have all the devices and materials necessary to complete the installation of the product.
- You should note your Protection Index (IP) and operating temperature to ensure that is suitable for the installation site.
- Provide the manual of the product to the user and let them know how to handle it in an emergency.
- If the automatism is installed on a gate with a pedestrian door, a door locking mechanism must be installed while the gate is in motion.
- Do not install the product "upside down" or supported by elements do not support its weight. If necessary, add brackets at strategic points to ensure the safety of the automatism.
- Do not install the product in explosive site.
- Safety devices must protect the possible crushing, cutting, transport and danger areas of the motorized door or gate.
- Verify that the elements to be automated (gates, door, windows, blinds, etc.) are in perfect function, aligned and level. Also verify if the necessary mechanical stops are in the appropriate places.
- The control board must be installed on a safe place of any fluid (rain, moisture, etc.), dust and pests.
- You must route the various electrical cables through protective tubes, to protect them against mechanical exertions, essentially on

01. SAFETY INSTRUCTIONS

the power supply cable. Please note that all the cables must enter the control board from the bottom.

- If the automatism is to be installed at a height of more than 2,5m from the ground or other level of access, the minimum safety and health requirements for the use of work equipment workers at the work of Directive 2009/104/CE of European Parliament and of the Council of 16 September 2009.
- Attach the permanent label for the manual release as close as possible to the release mechanism.
- Disconnect means, such as a switch or circuit breaker on the electrical panel, must be provided on the product's fixed power supply leads in accordance with the installation rules.
- If the product to be installed requires power supply of 230Vac or 110Vac, ensure that connection is to an electrical panel with ground connection.
- The product is only powered by low voltage safety with control board (only at 24V motors).
- Parts/products weighing more than 20 kg must be handled with special care due to the risk of injury. It is recommended to use suitable auxiliary systems for moving or lifting heavy objects.
- Pay special attention to the danger of falling objects or uncontrolled movement of doors/gates during the installation or operation of this product.

WARNINGS FOR USERS

- Keep this manual in a safe place to be consulted whenever necessary.
- If the product has contact with fluids without being prepared, it must immediately disconnect from the power supply to avoid short circuits, and consult a specialized technician.
- Ensure that technician has provided you the product manual and informed you how to handle the product in an emergency.
- If the system requires any repair or modification, unlock the automatism, turn off the power and do not use it until all safety

conditions have been met.

- In the event of tripping of circuits breakers or fuse failure, locate the malfunction and solve it before resetting the circuit breaker or replacing the fuse. If the malfunction is not repairable by consult this manual, contact a technician.
- Keep the operation area of the motorized gate free while the gate in in motion, and do not create strength to the gate movement.
- Do not perform any operation on mechanical elements or hinges if the product is in motion.

RESPONSABILITY

- Supplier disclaims any liability if:
 - Product failure or deformation result from improper installation use or maintenance!
 - Safety norms are not followed in the installation, use and maintenance of the product.
 - Instructions in this manual are not followed.
 - Damaged is caused by unauthorized modifications
 - In these cases, the warranty is voided.

MOTORLINE ELECTROCELOS SA.

Travessa do Sobreiro, nº29
4755-474 Rio Côvo (Santa Eugénia)
Barcelos, Portugal

SYMBOLS LEGEND:



• Important safety notices



• Useful information



• Programming information



• Potentiometer information



• Connectors information



• Buttons information

02. CONTROL BOARD

TECHNICAL CHARACTERISTICS

The MC80 is an electronic control board for automating dock leveler.

• Power	Three-phase 380Vac
• Output for motor	380Vac 1500W Max.
• Output for auxiliary accessories	24Vdc 12W Max.
• Fuse F1/F2/F3	10A
• Fuse F4	125mA
• Working Temperature	-25°C to +55°C
• Control board dimension	198x134 mm

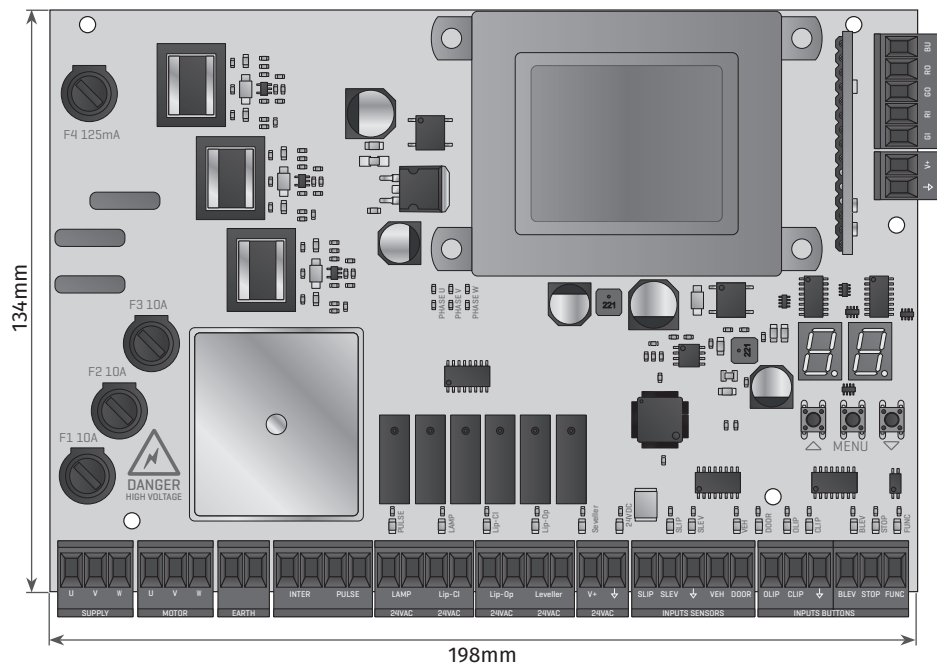

02. CONTROL BOARD

CONNECTOR LEGEND

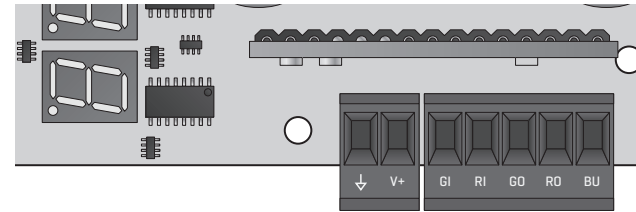

↓ V+	Power input for traffic lights and buzzer 24vdc max. 200ma.
GI	Open collector connection for internal traffic light green light 24vdc max. 200ma.
RI	Open collector connection for internal traffic light red light 24vdc max. 200ma.
GO	Open collector connection for external traffic light green light 24vdc max. 200ma.
RO	Open collector connection for external traffic light green light 24vdc max. 200ma.
BU	Open collector connection for buzzer 24vdc max. 200ma.

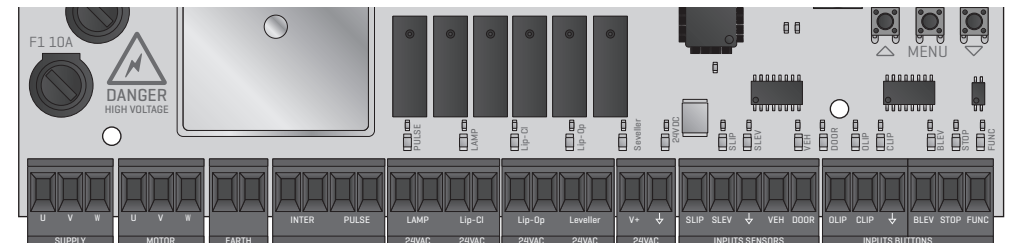

Supply	Three-phase 380V input for powering the motor as well as the transformer for the digital part
Motor	Output for three-phase motor up to 1500W
Earth	Connecting the motor ground cables and power input
Inter	Interlock door: The “interlock door” output can be integrated into the door control stop circuit. The contact is opened in case of: - The dock leveler is not in the initial position. - The dock leveler power failure. - Emergency shutdown.

02. CONTROL BOARD

CONNECTOR LEGEND

Pulse	IMPULS CLOSE: The “impulse close” output can be applied in the case of a door with automatic closing or if you want additional security so that the door is never closed with the dock leveler out of its initial position. The contact is opened while the dock leveler is being operated or is out of its initial position. The contact is closed whenever the dock leveler reaches the initial position.	
Lamp	Light indicator that will be placed on the front panel of the control board.	
	Lights up for 500ms x1 waits 2sec.	Whenever the emergency push button is activated.
	Lights up for 500ms x2 waits 2sec.	Whenever a phase failure is detected. This error remains until a button is pressed.
	Lights up for 500ms x3 waits 2sec.	Whenever wrong phase sequence is detected. This error remains until a button is pressed.
	Lights up for 500ms x4 waits 2sec.	Whenever current above the defined limit is detected. This error remains until a button is pressed.
	Lights up for 500ms x6 waits 2sec.	If the DOOR input is activated and its status changes to error. This error remains until a button is pressed.
	Lights up for 500ms x6 waits 2sec.	If the VEH input is selected as WheelBlock and it is activated. This error remains until a button is pressed.
LIP-CL	Output for lip solenoid valve CLOSING	
LIP-OP	Output for lip solenoid valve OPENING	
LEVELLER	Output for dock leveler solenoid valve	
POWER 24V+	24V output for external accessories	
SLIP	Lip limit switch sensor in initial position. NC Circuit	
SLEV	Dock leveler limit switch sensor in initial position. NC Circuit	
VEH	Vehicle sensor. The vehicle detector recognizes that the truck is in the correct position and signals this optically and acoustically. Any type of sensor that has dry contact can be used and can be NC or NO. The sensor input logic can be changed in parameterization. The operating mode can be chosen in parameterization.	

02. CONTROL BOARD

CONNECTOR LEGEND

DOOR	Open door position sensor input. Different types of sensors can be used as long as it is dry contact. The sensor contact mode can be changed in parameterization as well as its functionality.
OLIP	Connection for lip opening button
CLIP	Connection for lip closing button
BLEV	Connecting the button to open the dock leveler
STOP	Normally closed button for connecting an external emergency button that causes the entire system to be turned off
FUNC	Connection for autoreturn/confirmation button

OPERATING MODE

To be able to access the menu, the dock leveler must be in standby mode or in a floating position!

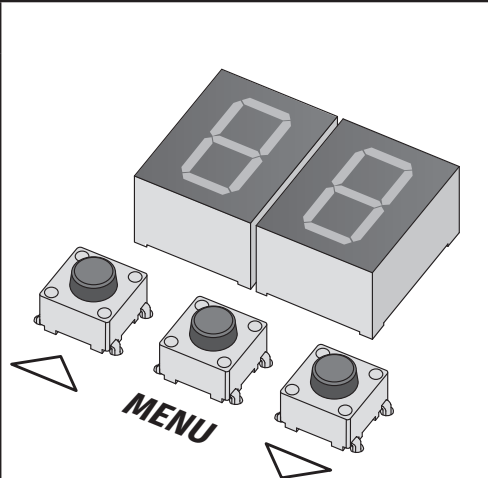
	MENU NAVIGATION
	<p>01• Press the MENU button once.</p> <p>02• Select the menu you want to program with the UP and DOWN buttons.</p> <p>03• Press the MENU button once to enter the menu.</p> <p>04• Select the submenu you want to program with the UP and DOWN buttons.</p> <p>05• Press the MENU button once to edit the parameter value.</p> <p>06• Select the value you want to program with the UP and DOWN buttons.</p> <p>07• To save the chosen value, press the MENU button for one second. The display will flash to indicate that the value has been changed.</p>

To be able to access the menu, the dock leveler must be in **standby mode** or in a **floating position**!



To go back, press the UP and DOWN buttons at the same time.
If you do not press any button for 10 seconds, the control board will return to standby.

02. CONTROL BOARD

WITH HINGED LIP WITHOUT AUTOMATIC RETURN

Pressing **BLEV** dock leveler push button, will activate the motor relay and the solenoid valve relay in human presence operation mode, then raise the dock leveler.

The operator must press **BLEV** until the lip is extended, once it is, the **BLEV** button can be released and the motor relay will be turned off. The dock leveler must be raised at least during the time (**M1-T1**).

The dock leveler then automatically lowers to the docking edge of vehicle (floating position).

No auto return

01 • Press the **BLEV** button, activating the motor pump relay and solenoid valve relay until it is completely folded.

02 • Release the **BLEV** button and the motor pump relay is switched off.

03 • The dock leveler automatically lowers to the initial position.

04 • After the time (**M1-T5**) the dock leveler is in the initial position or **SLEV** is detected.

WITH HINGED LIP WITH AUTOMATIC RETURN

Pressing **BLEV** dock leveler push button, will activate the motor pump relay and the solenoid valve relay in human presence operation mode, then raise the dock leveler.

The operator must press **BLEV** until the lip is extended, once it is, the **BLEV** button can be released and the motor pump relay will be turned off. The dock leveler must be raised at least during the time (**M1-T1**).

The dock leveler then automatically lowers to the docking edge of vehicle (floating position).

Automatic return

01 • Press the **FUNC** button for 1 second.

02 • The dock leveler is raised by time (**M1-T3**) activating the motor pump relay and solenoid valve relay.

03 • As soon as the time (**M1-T3**) reaches the end, the motor pump relay turns off.

04 • The dock leveler automatically lowers to the initial position.

05 • After the time (**M1-T5**) the dock leveler is in the initial position or **SLEV** is detected.

WITH EXTENDABLE LIP WITH AUTOMATIC RETURN

Pressing **BLEV** dock leveler push button, will activate the motor pump relay and the solenoid valve relay in human presence operation mode, then raise the dock leveler. The dock leveler must be raised for at least the time (**M1-T1**).

After reaching the ideal position, the dock leveler can be stopped, so the user can release the **BLEV** push button, disconnecting the motor pump relay as well as the solenoid valve relay. The dock leveler will remain in this position for 5 seconds and during this time the lip must be positioned using the **OLIP** button. If no button is pressed, the dock leveler drops back to the initial position, activating the solenoid valve relay.

The lip can be positioned with the buttons out in the Human Presence operating mode using the **OLIP** button, activating the motor pump relay as well as the **LIP-OP** relay. The lip must be expelled for at least the minimum lip exit time (**M2-T1**). If the time (**M2-T2**), is reached, the lip stops automatically, turning off the **LIP-OP > MOTOR** relay and activating the solenoid valve relay. After releasing the **OLIP** button and turning off the **LIP-OP relay > MOTOR** and activating the solenoid valve relay, the dock leveler automatically lowers to the docking edge of vehicle (floating position)

02. CONTROL BOARD

WITH EXTENDABLE LIP WITH AUTOMATIC RETURN

Automatic return

01 • Press the **FUNC** button for 1 second.

02 • The dock leveler is raised by time (**M1-T3**) activating the motor pump relay and solenoid valve relay.

03 • When reaching the value of (**M1-T3**) the solenoid valve relay is turned off.

04 • The lip is retracted over time (**M2-T3**) activating the **LIP-CL**.

05 • Upon reaching the value of (**M2-T3**) the **LIP-CL** relay is turned off.

06 • The dock leveler is raised by time (**M1-T4**) activating the solenoid valve relay.

07 • When this value of (**M1-T4**) is reached, the solenoid valve relay is turned off.

08 • The lip is completely retracted by activating the **LIP-CL** relay until it reaches the **SLIP** limit switch or when it reaches the time of (**M2-T4**) if **SLIP** is not used.

09 • Upon reaching this value of (**M2-T4**) or **SLIP**, the **LIP-CL** relay is turned off.

10 • The dock leveler lowers automatically, activating the solenoid valve relay to the initial position.

11 • When reaching the **SLEV** sensor or reaching the time (**M1-T5**) the motor pump relay is switched off.

FREE

Pressing **BLEV** dock leveler push button, will activate the motor relay and the solenoid valve relay in human presence operation mode, then raise the dock leveler.

The operator must press **BLEV** until the lip is extended, once it is, the **BLEV** button can be released and the motor relay will be turned off.

The dock leveler then automatically lowers to the docking edge of vehicle (floating position).

No auto return

01 • Pressing the **FUNC** button for 1 sec.

02 • Release the **BLEV** button and the motor pump relay is switched off.

03 • The dock leveler automatically lowers to the initial position.

03. PROGRAM

M FUNCTIONS

70 OPERATING MODE			
54	00	With hinged lip without autoreturn	01 (Factory value) 0 99
	01	With hinged lip with autoreturn	
	02	With extendable lip with autoreturn	
	03	Free	
The dock leveler returns to the initial position using the FUNC button, where the return occurs automatically			

71 DOCK LEVELER TIMING		
81	Minimum time to raise the dock leveler	10 (Factory value) 0 99
82	Maximum working time of the pump relay so that, due to any error, it always remains working. (EX: button always pressed)	15 (Factory value) 0 99
MIN Value Depends on the Value selected in T1		
83	First time to raise the dock leveler in auto return in position tied to the truck.	05 (Factory value) 0 99
MAX Value Depends on Value selected in T4		
84	Second time to raise the dock leveler in auto return in the open position after retracting the Lip until the time of (M2-T3).	30 (Factory value) 0 99
85	Time for the dock leveler to lower to the initial position.	15 (Factory value) 0 99
86	Not used	05 (Factory value) 0 99
87	Dock leveler lower time to initial position. (hinged lip mode)	10 (Factory value) 0 99
88	Time to deactivate the dock leveler solenoid valve.	10 (Factory value) 0 99
Whenever this is at the initial point, time begins to count down for the dock leveler solenoid valve to deactivate. If this value is set to 0, the solenoid valve will remain activated even in standby.		

03. PROGRAM

M FUNCTIONS

72 TELESCOPIC LIP TIMING		
81	Minimum time that the lip can come out regardless of what the user presses the button	05 (Factory value) 0 99
MAX value Depends on selected value M2-T2		
82	Maximum time in which the user can press the lip exit button.	10 (Factory value) 0 99
83	Minimum lip retraction time.	05 (Factory value) 0 99
MAX value Depends on selected value M2-T4		
84	Maximum lip retraction time.	00 (Factory value) 0 99

73 PUMP SETUP			
A7	01	Motor up to-->500W	03 (Factory value) 1 5
	02	Motor up to-->1000W	
	03	Motor up to-->1500W	
	04	Motor up to-->2000W	
	05	Motor up to-->2500W	
CF	Defines minimum time to give an overcurrent error.	05 (Factory value) 1 5 (value in sec.)	
Time that the control board can be overcurrent until it gives an error			
PS	The control board allows you to detect whether the phases are in the correct sequence so that the pump works correctly		00 (Factory value) 0 1
	00	Disable phase sequence detection	
PE	The control board has the ability to measure whether the 3 phases are working correctly if there is a lack of a phase the control board will give an error.		01 (Factory value) 0 1
	00	Disables phase failure detection	
01	Enables phase failure detection		

03. PROGRAM

M FUNCTIONS

74 SLIP AND SLEV INPUT			
LE	00	If the lip contains a sensor to indicate that it is closed, this parameter must be activated.	00 (Factory value) 0 1
	01		
BE	00	If the dock leveler has a sensor to indicate that it is closed, this parameter must be activated.	00 (Factory value) 0 1
	01		
LN	00	Normally closed (NC)	00 (Factory value) 0 1
	01	Normally open (NO)	
BN	00	Normally closed (NC)	00 (Factory value) 0 1
	01	Normally open (NO)	
75 VEH INPUT			
BE	00	Turns off	00 (Factory value) 0 1
	01	Turns on	
BN	00	Normally closed (NC)	00 (Factory value) 0 1
	01	Normally open (NO)	
BN	00	Vehicle sensor	00 (Factory value) 0 1
	01	Wheel lock	
BA	00	Optical and acoustic vehicle detection. When a vehicle is in front of the door and activates the vehicle sensor, this is signaled by red traffic lights and the buzzer. The Interlock contact is released so that the door can be moved. (INTER)	00 (Factory value) 0 1
	01	Optical and acoustic vehicle detection. When a vehicle is in front of the door and activates the vehicle sensor, this is signaled by red traffic lights and the buzzer.	

03. PROGRAM

M FUNCTIONS

UR	00	If the WHEELBLOCK is activated with the dock leveler out of the standby position, the traffic lights, lamp output and buzzer signal this until the WHEELBLOCK is restored or the dock leveler is placed in the standby position. The Interlock contact is released so that the door can be moved.	00 (Factory value) 0 1 2
	01	If WHEELBLOCK is activated with the dock leveler out of standby position, the traffic lights, lamp output and buzzer signal that all buttons are blocked.	
	02	When a vehicle passes in front of the door and activates the vehicle sensor, this is signaled by red traffic lights and the buzzer. If the WHEELBLOCK is activated with the dock leveler out of the standby position, the traffic lights, lamp output and buzzer signal this until the WHEELBLOCK is restored or the dock leveler is placed in the standby position. The Interlock contact is released so that the door can be moved. Optical and acoustic vehicle detection.	

03. PROGRAM

M FUNCTIONS

76 DOOR AND FUNC INPUT		
8E Turn off/on DOOR input	00 Turn off input	00 (Factory value)
	01 Turn on input	
8A Defines the DOOR input logic (NO/NC)	00 Normally closed (NC)	01 (Factory value)
	01 Normally open (NO)	
<p>Dock leveler in initial position Whenever the dock leveler is in the initial position and this input is activated, the dock leveler does not move and if the up button is pressed, the lamp output will flash 5 times to signal the operation.</p> <p>Dock leveler in floating position If this input is activated with the dock leveler in floating position, the dock leveler stops and both traffic lights change to red, the buttons are blocked and the hydraulics are turned off.</p>		
E0 Defines the function of the FUNC input	<p>Automatic return function In this mode the input is used to make the Autoreturn mode if defined in the parameter M0 ->1 or 2</p>	00 (Factory value)
	<p>Confirmation function The external green traffic light only changes to green if the dock leveler is in the initial position and the Wheelblock input is removed and the confirmation button has been pressed. Please note that this function only works if menu M5 ->2 is activated.</p>	





03. PROGRAM

M FUNCTIONS

77 INTERLOCK OUTPUT		
8E Turns off/on the INTERLOCK function	00 Turns off	00 (Factory value)
	01 Turns on	
8A Defines the output logic (NO/NC)	00 Normally closed (NC)	00 (Factory value)
	01 Normally open (NO)	
<p>Door interlock: The "door interlock" output can be integrated into the door control stop circuit. The contact is open in case of: Activation condition 1- The dock leveler is not in the initial position 2- The dock leveler power failure 3- Emergency shutdown</p>		
PU Defines the operational logic of the PULSE output	00 The output is active whenever the leveler is not in the initial position.	00 (Factory value)
	01 The output generates a pulse whenever it returns to the initial position.	
78 BUZZER		
8E Buzzer Output / FAN	<p>It produces a warning signal, for example, when the wheel's WHEEBLOCK is released during the loading procedure.</p> <p>It is selected as buzzer output</p>	00 (Factory value)
	<p>After reaching the loading position, the light turns on and remains on until the dock leveler is back in its initial position.</p> <p>It is selected as FAN</p>	
8A Intermittent or constant output	00 Intermittent	00 (Factory value)
	01 Constant	
8E Buzzer signaling time	Defines the buzzer time whenever it is activated	02 (Factory value)

03. PROGRAM

M FUNCTIONS

79 TRAFFIC LIGHTS		
LE Turn traffic lights off/on	00 Turns off 01 Turns on	01 (Factory value)  
LE Waiting time to change traffic lights	The time it takes for traffic lights to change color whenever a vehicle is detected.	02 (Factory value)  

04. DISPLAY

DISPLAY INDICATIONS

MENU	DESCRIPTION
88	Control board on standby
88	Floating position
88 (intermittent)	Minimum time to raise the dock leveler
88 (intermittent)	Minimum lip opening time
88↑	Dock leveler going up
88↓	Dock leveler going down
088	Lip opening
098	Lip closing
58	Emergency button pressed
88	Door sensor activated while dock leveler is moving
88	Overcurrent detection
88	Motor phase off
88	Incorrect motor phase sequence

05. CONNECTION DIAGRAM

WITH HINGED LIP WITHOUT AUTOMATIC RETURN

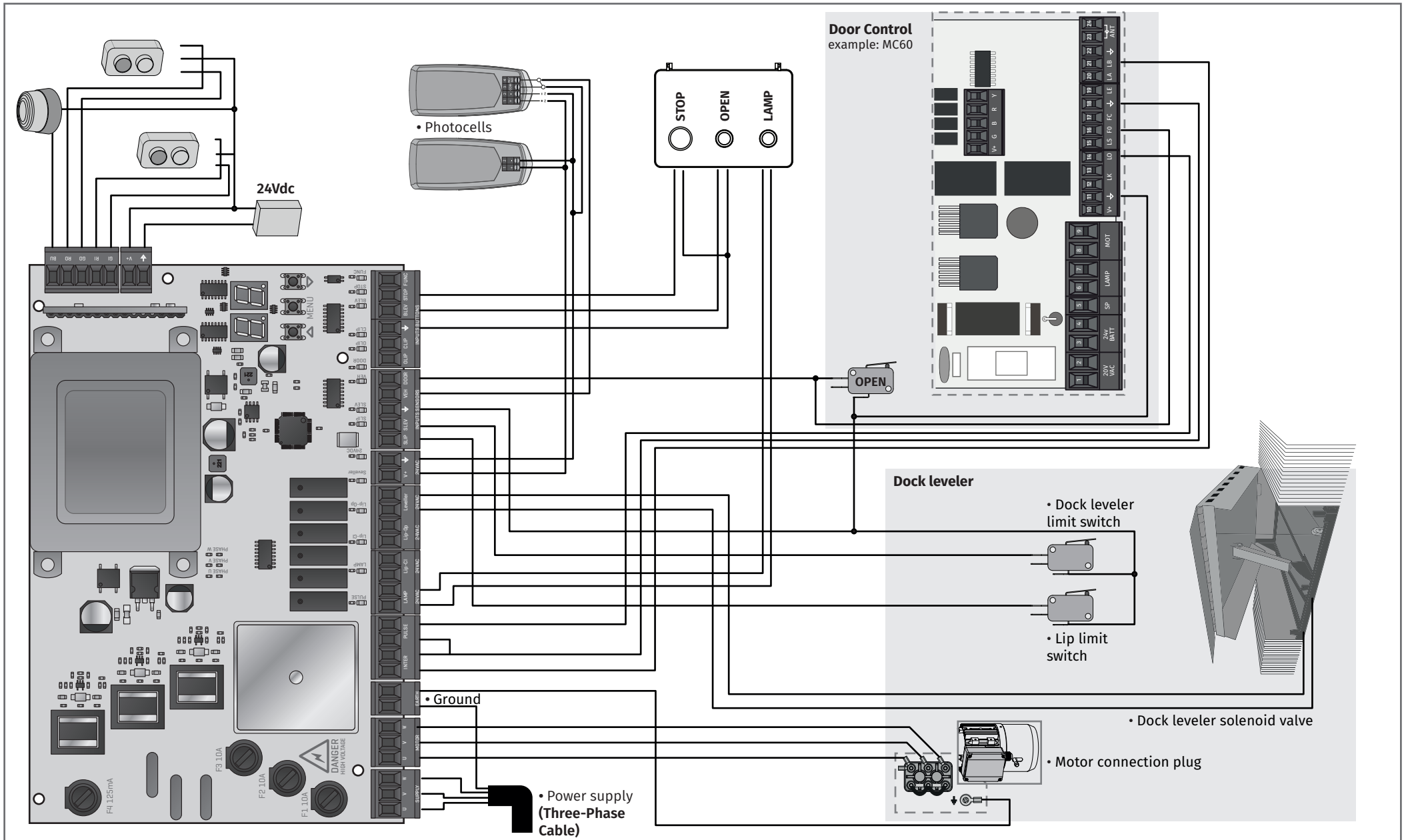

05. CONNECTION DIAGRAM

WITH HINGED LIP WITH AUTOMATIC RETURN

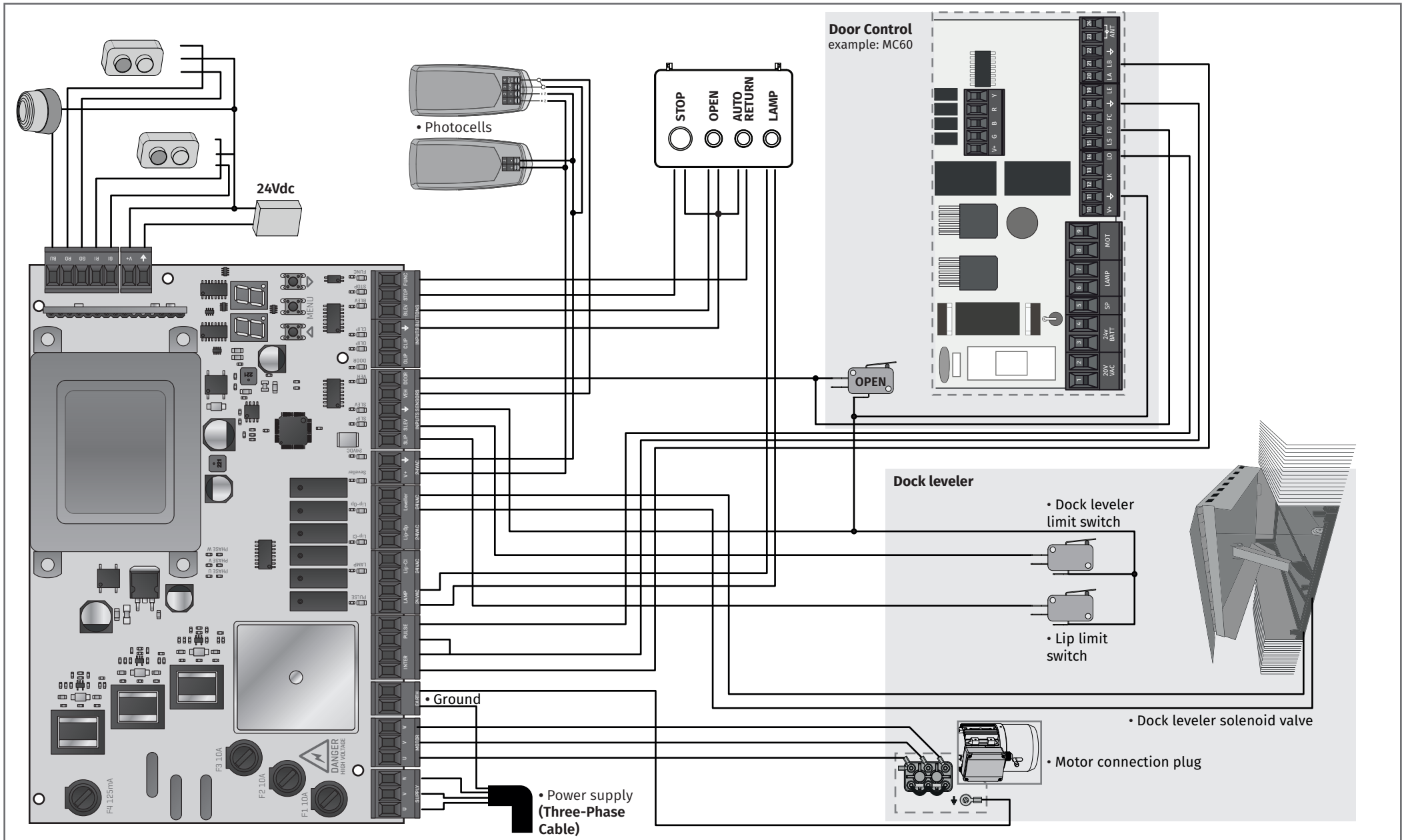

05. CONNECTION DIAGRAM

WITH EXTENDABLE LIP WITH AUTOMATIC RETURN

