



motorline
PROFESSIONAL

MX92N

USER / INSTALLER MANUAL



Correct disposal of this product
(Electrical and electronic equip-
ment waste).

EN

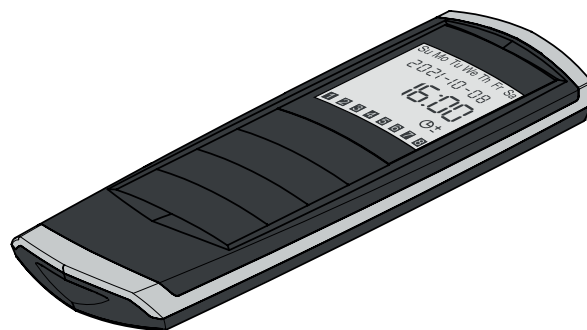

V1.0
REV. 10/2021

Technical characteristics

• Power Supply	3V(CR2430)
• Working temperature	-20 to 55°C
• Transmission frequency	433MHz
• Range	40m
• Number of channels	8 channels and 3 groups
• Code type	Rolling Code
• Dimensions	45x130x12mm

1	Week days
2	Current date
3	Current hour
4	Signal transmission
5	Programming modes
6	Channel
7	Up
8	Confirm/Stop
9	Down
10	Return
11	Advance
12	Time
13	Select
14	Battery

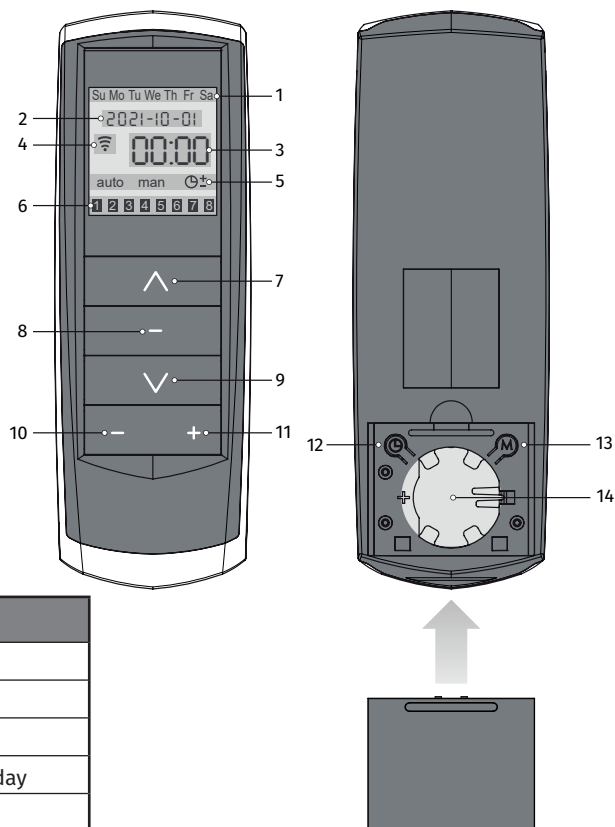

DESCRIPTION:	
man • manual	Su • Sunday
auto • automatic	Mo • Monday
⌚ ± • random	Tu • Tuesday
	We • Wednesday
	Th • Thursday
	Fr • Friday
	Sa • Saturday

PRE-PROGRAMMING

- When a battery is placed on the transmitter, this turns on all the characters on the display for 2 seconds. After this time stay in normal working.
- If more than 10 seconds passes without pressing any key, the remote control automatically exits programming and returns to standby mode, without record any change.

• Factory values:

- the display shows initially: wednesday, 2014-01-01, 00:00h.
- manual mode active.
- Group 1 has the channels 1, 3, 5 and 7 memorized.
- Group 2 has the channels 2, 4, 6 and 8 memorized.

TRANSMISSION SIGNAL

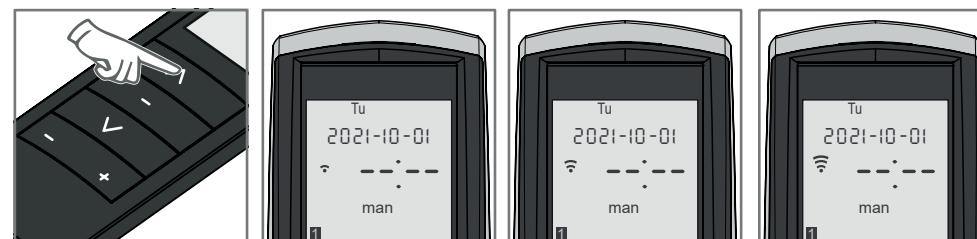

Each time you press ^ or v, the display will show  in dynamic mode, indicating the signal sending. The signal goes off when you stop pressing the button.

CONTROL OPTIONS

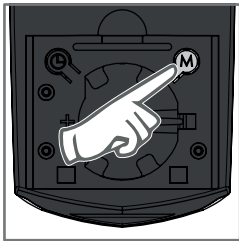

• Use M to scroll through the different controls.

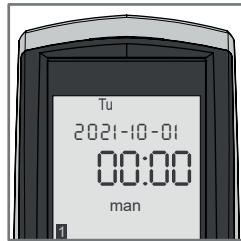

• **MANUAL CONTROL (man)**
No timer function.

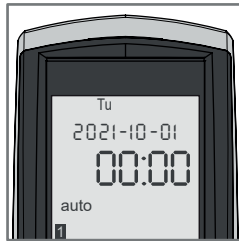

• **AUTOMATIC CONTROL (auto)**
With timer function.

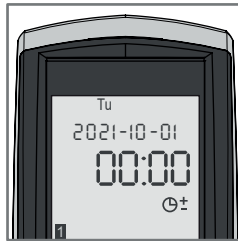

• **RANDOM CONTROL (⊖±)**
With random timing function. The random remote control is implemented in accordance with Standard timing (approx. 15 min.).

SET CURRENT DATE AND TIME

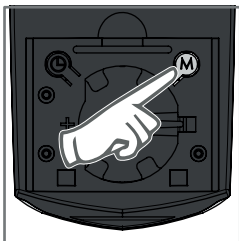

1 • Press M until the remote control is in manual mode.

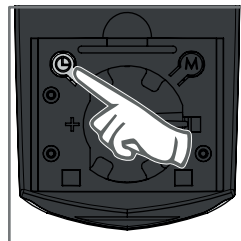

2 • Press ⊖ for 3 seconds and the year will flash.

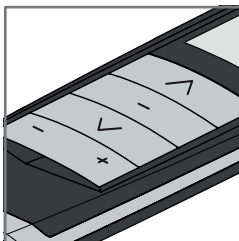

3 • Use the - and + to scroll through the various values that define the date / time and the ^ / v keys to change each value.

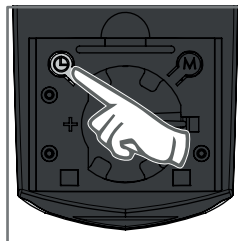

4 • In the end, press the ⊖ button to confirm.

CHOOSE CHANNEL/GROUP

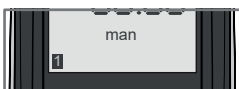

The display always shows what the channel functions. When you press ^ - v an order will be transmitted by the indicated channel at the bottom of the display.

In automatic or random mode, use - and + to select the group 1 or

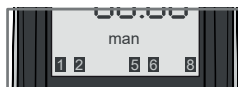
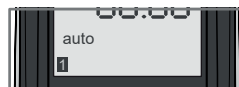
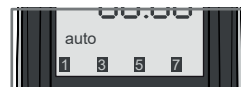

group 2. Press ⊖ for 3 seconds to enter the selected group. Use - and + to select channels. To set a channel in the group, press ^ once. To remove if from the group, press v once. When the number is flashing, it means that does not yet belong to the group. When the number is fixed, it belongs to the group.

PROGRAMMING TIMER

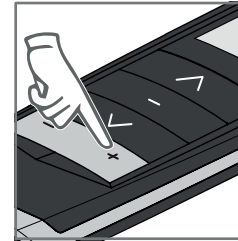

1 • Select the channel you want using the buttons - and +.

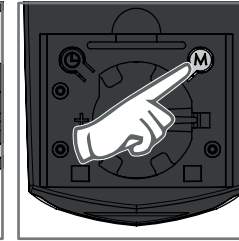

2 • Press M until if you put in automatic mode (auto).

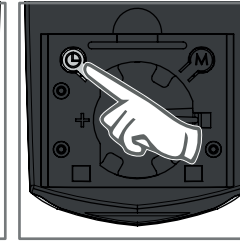

3 • Press ⊖ for 3 seconds. The Su will flash and the zone of the time will appear empty.

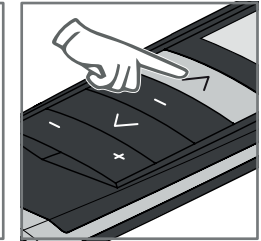

4 • Using ^ / v, select the day you want to program.



5 • Press + to now set the time and use ^ / v to change it.



6 • Press again + to set the minutes and use ^ / v to change them.



Will be defining the ascent.



Will be defining the descent.

NOTE • When you end the ascent and descent programming, the system automatically advances to the next day. If you want to quit programming press ⊖ for 3 seconds.



Group 1 and 2 doesn't work with timer.

REMOVE TIMERS

Select the channel you want and insert  for the opening and closing times. Timers can only be deleted individually (channel by channel).



- MX92 was developed to function with MC4SP, MC4SPI, MC70, MC16 and MC18 control boards. When using other control boards may be working incompatibilities.
- The 3V lithium battery (CR2430) should be replaced once a year to ensure the correct operation of the transmitter;
- To replace the dead battery remove the plastic cover, remove the battery out and insert the new one, respecting the polarity shown on the container;
- The used battery must be placed in containers intended for this purpose.