



# MTT01

## USER'S AND INSTALLER'S MANUAL









# 00. CONTENT

## ÍNDEX

<b>01. SAFETY INSTRUCTIONS</b>	<b>1B</b>
<b>02. AUTOMATION</b>	
MTT01	4A
PACKING	4A
TECHNICAL CHARACTERISTICS	4B
DIMENSIONS	4B
<b>03. INSTALLATION</b>	
PRE-INSTALLATION	5A
GROUND PREPARATION	5A
INSTALLATION	5B
<b>04. CONNECTIONS</b>	
DIAGRAM	6
CONNECTORS DESCRIPTION	7
<b>05. PROGRAMMING</b>	
PRE-PROGRAMMING	8A
NAVIGATING THE MENUS	8A
L01 - L02 - L03 - L04	8B
L05 - L06 - L07 - L08 - L09	9A
L10 - L11 - L12 - L13 - L14	9B
L15 - L16 - L17 - L18 - L19	10A
<b>06. MAINTENANCE</b>	
MAINTENANCE	10B
<b>07. TROUBLESHOOTING</b>	
INSTRUCTIONS FOR FINAL CONSUMERS / SPECIALIZED TECHNICIANS	11

# 01. SAFETY INSTRUCTIONS

	This product is certified in accordance with European Community (EC) safety standards.
	This product complies with Directive 2011/65/EU of the European Parliament and of the Council, of 8 June 2011, on the restriction of the use of certain hazardous substances in electrical and electronic equipment and with Delegated Directive (EU) 2015/863 from Commission.
	(Applicable in countries with recycling systems). This marking on the product or literature indicates that the product and electronic accessories (eg. Charger, USB cable, electronic material, controls, etc.) should not be disposed of as other household waste at the end of its useful life. To avoid possible harm to the environment or human health resulting from the uncontrolled disposal of waste, separate these items from other types of waste and recycle them responsibly to promote the sustainable reuse of material resources. Home users should contact the dealer where they purchased this product or the National Environment Agency for details on where and how they can take these items for environmentally safe recycling. Business users should contact their vendor and check the terms and conditions of the purchase agreement. This product and its electronic accessories should not be mixed with other commercial waste.
	This marking indicates that batteries should not be discarded like other household waste at the end of their useful life. Batteries must be delivered to selective collection points for recycling.
	The different types of packaging (cardboard, plastic, etc.) must be subject to selective collection for recycling. Separate packaging and recycle it responsibly.
	This marking indicates that the product and electronic accessories (eg. charger, USB cable, electronic material, controls, etc.) are susceptible to electric shock by direct or indirect contact with electricity. Be cautious when handling the product and observe all safety procedures in this manual.

# 01. SAFETY INSTRUCTIONS

## **GENERAL WARNINGS**

- This manual contains very important safety and usage information. Read all instructions carefully before beginning the installation/usage procedures and keep this manual in a safe place that it can be consulted whenever necessary.
- This product is intended for use only as described in this manual. Any other enforcement or operation that is not mentioned is expressly prohibited, as it may damage the product and put people at risk causing serious injuries.
- This manual is intended firstly for specialized technicians, and does not invalidate the user's responsibility to read the "User Norms" section in order to ensure the correct functioning of the product.
- The installation and repair of this product may be done by qualified and specialized technicians, to assure every procedure are carried out in accordance with applicable rules and norms. Nonprofessional and inexperienced users are expressly prohibited of taking any action, unless explicitly requested by specialized technicians to do so.
- Installations must be frequently inspected for unbalance and the wear signals of the cables, springs, hinges, wheels, supports and other mechanical assembly parts.
- Do not use the product if it is necessary repair or adjustment is required.
- When performing maintenance, cleaning and replacement of parts, the product must be disconnected from power supply. Also including any operation that requires opening the product cover.
- The use, cleaning and maintenance of this product may be carried out by any persons aged eight years old and over and persons whose physical, sensorial or mental capacities are lower, or by persons without any knowledge of the product, provided that these are supervision and instructions given by persons with experienced in terms of usage of the product in a safe manner and who understands the risks and dangers involved.

- Children shouldn't play with the product or opening devices to avoid the motorized door or gate from being triggered involuntarily.
- If the power cable is damaged, it must be replaced by the manufacturer, after-sales service or similarly qualified personnel to avoid danger.
- The device must be disconnected from the electrical network when removing the battery.
- Ensure that blocking is avoided between the actuated part and its fixed parts due to the opening movement of the actuated part.

## **WARNINGS FOR TECHNICIANS**

- Before beginning the installation procedures, make sure that you have all the devices and materials necessary to complete the installation of the product.
- You should note your Protection Index (IP) and operating temperature to ensure that is suitable for the installation site.
- Provide the manual of the product to the user and let them know how to handle it in an emergency.
- If the automatism is installed on a gate with a pedestrian door, a door locking mechanism must be installed while the gate is in motion.
- Do not install the product "upside down" or supported by elements do not support its weight. If necessary, add brackets at strategic points to ensure the safety of the automatism.
- Do not install the product in explosive site.
- Safety devices must protect the possible crushing, cutting, transport and danger areas of the motorized door or gate.
- Verify that the elements to be automated (gates, door, windows, blinds, etc.) are in perfect function, aligned and level. Also verify if the necessary mechanical stops are in the appropriate places.
- The control board must be installed on a safe place of any fluid (rain, moisture, etc.), dust and pests.
- You must route the various electrical cables through protective tubes, to protect them against mechanical exertions, essentially on

# 01. SAFETY INSTRUCTIONS

the power supply cable. Please note that all the cables must enter the control board from the bottom.

- If the automatism is to be installed at a height of more than 2,5m from the ground or other level of access, the minimum safety and health requirements for the use of work equipment workers at the work of Directive 2009/104/CE of European Parliament and of the Council of 16 September 2009.
- Attach the permanent label for the manual release as close as possible to the release mechanism.
- Disconnect means, such as a switch or circuit breaker on the electrical panel, must be provided on the product's fixed power supply leads in accordance with the installation rules.
- If the product to be installed requires power supply of 230Vac or 110Vac, ensure that connection is to an electrical panel with ground connection.
- The product is only powered by low voltage safety with control board (only at 24V motors).
- Parts/products weighing more than 20 kg must be handled with special care due to the risk of injury. It is recommended to use suitable auxiliary systems for moving or lifting heavy objects.
- Pay special attention to the danger of falling objects or uncontrolled movement of doors/gates during the installation or operation of this product.

## WARNINGS FOR USERS

- Keep this manual in a safe place to be consulted whenever necessary.
- If the product has contact with fluids without being prepared, it must immediately disconnect from the power supply to avoid short circuits, and consult a specialized technician.
- Ensure that technician has provided you the product manual and informed you how to handle the product in an emergency.
- If the system requires any repair or modification, unlock the automatism, turn off the power and do not use it until all safety

conditions have been met.

- In the event of tripping of circuits breakers or fuse failure, locate the malfunction and solve it before resetting the circuit breaker or replacing the fuse. If the malfunction is not repairable by consult this manual, contact a technician.
- Keep the operation area of the motorized gate free while the gate in in motion, and do not create strength to the gate movement.
- Do not perform any operation on mechanical elements or hinges if the product is in motion.

## RESPONSABILITY

- Supplier disclaims any liability if:
  - Product failure or deformation result from improper installation use or maintenance!
  - Safety norms are not followed in the installation, use and maintenance of the product.
  - Instructions in this manual are not followed.
  - Damaged is caused by unauthorized modifications
  - In these cases, the warranty is voided.

## **MOTORLINE ELECTROCELOS SA.**

Travessa do Sobreiro, nº29  
4755-474 Rio Côvo (Santa Eugénia)  
Barcelos, Portugal

## SYMBOLS LEGEND:



• Important safety notices



• Useful information



• Programming information



• Potentiometer information



• Connectors information



• Buttons information

## 02. AUTOMATION

### MTT01



**MTT01** is a turnstile for easy pedestrian crossing with the possibility of automatic opening in both directions (bidirectional), when a 2nd turnstile is applied.

### PACKING

Inside the package you will find the following components:

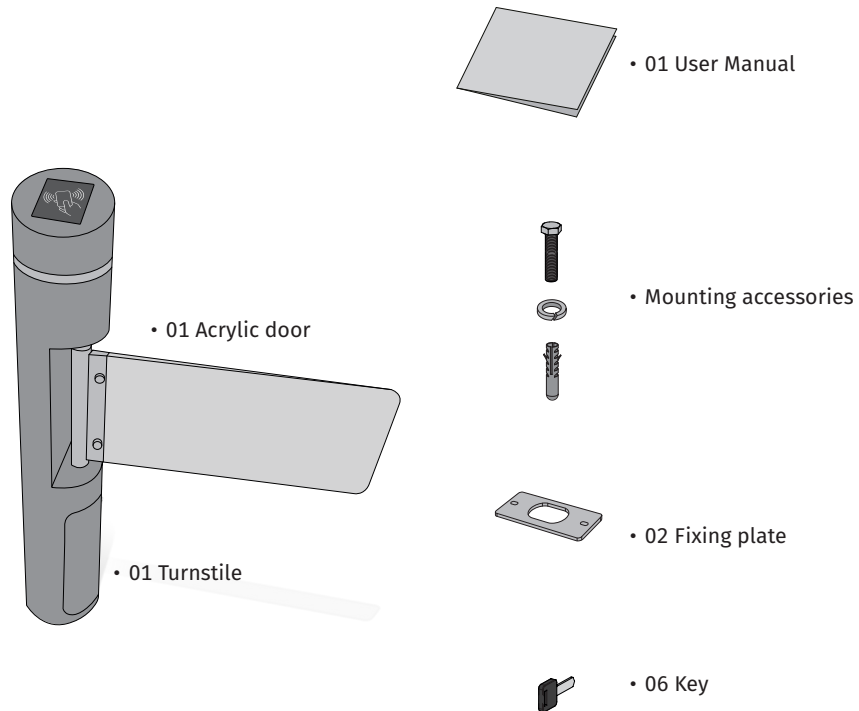

## 02. AUTOMATION

### TECHNICAL CHARACTERISTICS

	MTT01
• Power supply	230 Vac
• Power	70W
• Frequency	50~60 Hz
• Passage width	600mm*
• Working temperature	-25°C ~ 55°C
• Mechanism	Electromagnetic
• IP	IP56
• Passages per minute	30 - 40 people / min

\* In the case of having two MTT01 turnstiles, the passage width is 600mm-1200mm.

### DIMENSIONS

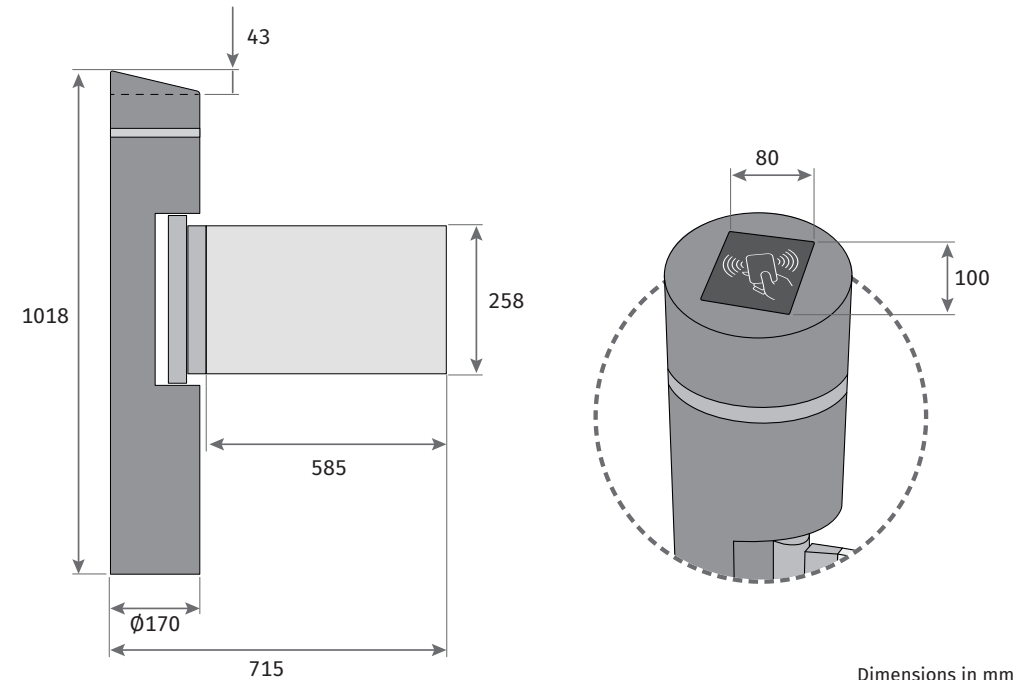

Dimensions in mm

## 03. INSTALLATION

### PRE-INSTALLATION

- Turnstile users must not open the mechanism. Maintenance and repair work should only be carried out by specialized personnel. Unconscious interventions can lead to dangerous situations for the mechanism and for the user
- Turnstiles must be protected against any type of shock and vibration.
- Do not insert any voltage beyond the values specified in the technical characteristics of the turnstile.
- Do not exceed the relative humidity and operating temperature values specified in the technical characteristics of the turnstile.
- Check all connections and verify that they are correct before supplying power to the turnstile.
- Do not use any equipment on the turnstile other than the hardware and parts provided by the producer.
- Disconnect the power supply in the event of an electrical failure in the turnstiles. Please contact the supplier directly without intervening in the product.
- Make sure the power was cut before proceeding to the maintenance / cleaning the turnstiles.
- The inside of the turnstile must not come into contact with water. Do not use the turnstile in high magnetic fields.
- The turnstile cannot be stored or operated in a humid environment.
- Do not continue to use your turnstile if it is damaged or defective. Contact us and inform the technical service of the product without delay.
- Do not allow children or unauthorized persons to play with the turnstile.

### GROUND PREPARATION

- The floor on which the turnstiles are to be mounted must be completely flat and balanced.
- Installations should not be made if there are bumps and slopes on the floor.
- The assembly must not be done on unstable floors (example: soil, sand, gravel, plaster).
- There must not be installation or wiring under the floor where the tourniquet will be installed (If it is not possible to fulfill this requirement, the installation must be specified according to a project).
- No dust should enter the holes when mounting the turnstile on the floor.
- If possible, remove dust with a pneumatic hose or similar tools.

## 03. INSTALLATION

### INSTALLATION

#### • INSTALL TURNSTILE

- 1 Open the front plate of the turnstile with one of the opening keys.
- 2 Loosen the circuit breaker screw and remove it. (Secure the circuit breaker at the end of step 5)
- 3 Mark the drilling areas according to the holes in the bottom of the turnstile. Remove the turnstile and drill the floor.
- 4 Place the turnstile at the installation site and pass the power cable (230V).
- 5 Insert the bushings (x4), nuts (x4) and screws (x4) into the holes. Tighten with a wrench.

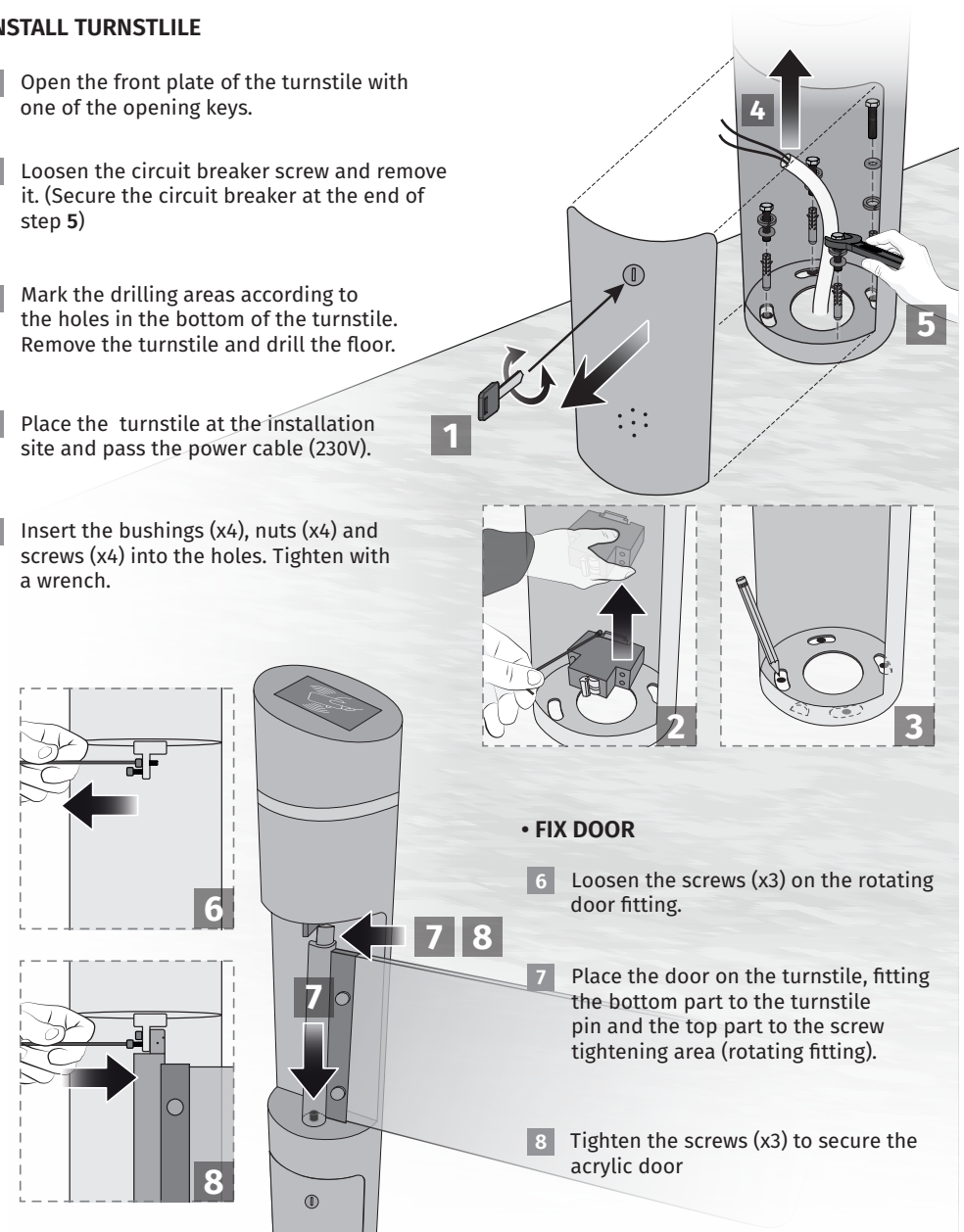

# 04. CONNECTIONS

## DIAGRAM

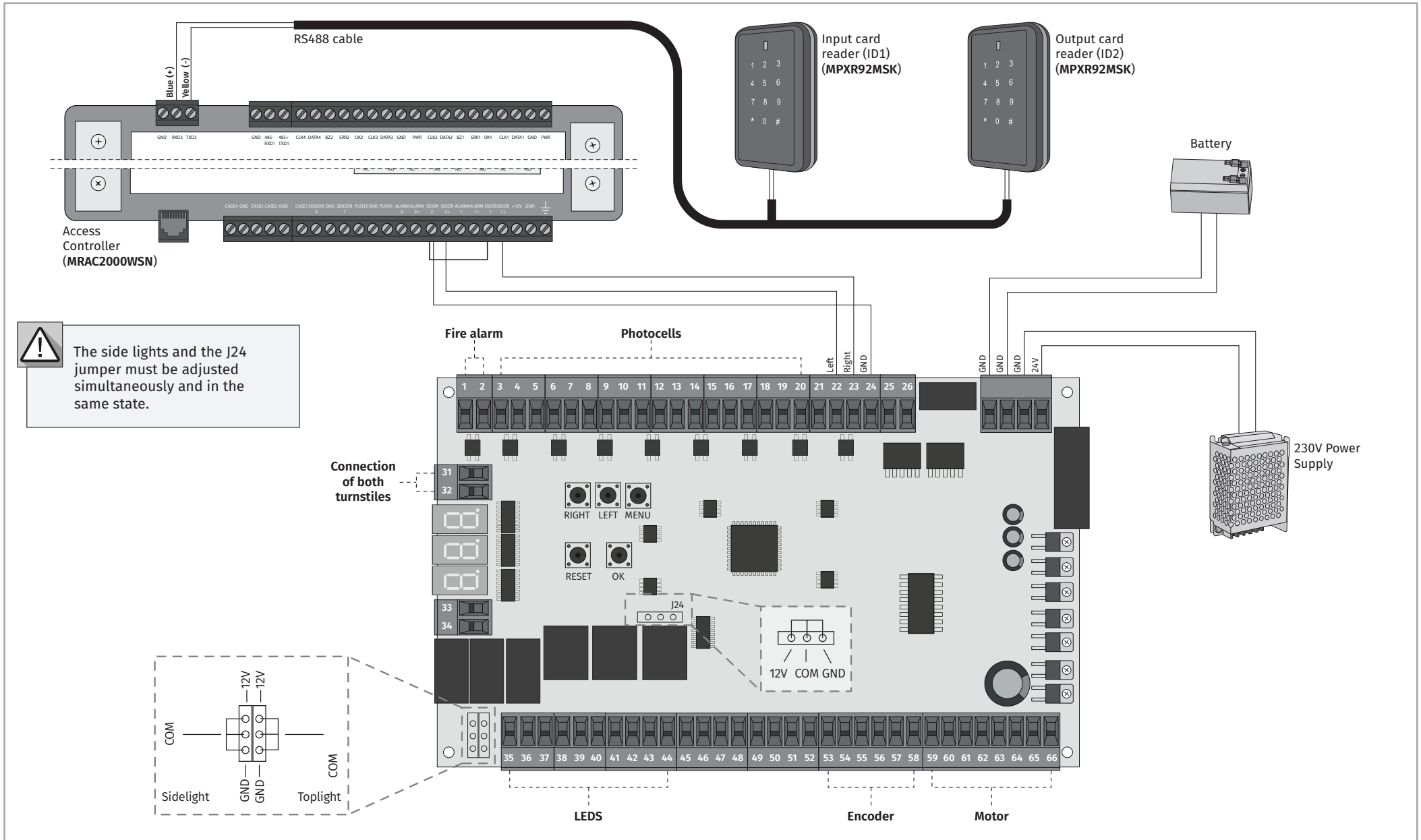

**!** The side lights and the J24 jumper must be adjusted simultaneously and in the same state.

# 04. CONNECTIONS

## CONNECTORS DESCRIPTION

<b>FIRE ALARM</b>	Fire signal input:	1 • NO 2 • COM
<b>PHOTOCELL 6</b>	First infrared sensor input in direction 2:	3 • 12V 4 • Photocell 6 5 • GND
<b>PHOTOCELL 5</b>	Second infrared sensor input in direction 2:	6 • 12V 7 • Photocell 5 8 • GND
<b>PHOTOCELL 4</b>	Segunda entrada do sensor de infravermelhos anti-esmagamento:	9 • 12V 10 • Photocell 4 11 • GND
<b>PHOTOCELL 3</b>	Primeira entrada do sensor de infravermelhos anti-esmagamento:	12 • 12V 13 • Photocell 3 14 • GND
<b>PHOTOCELL 2</b>	Second infrared sensor input in direction 1:	15 • 12V 16 • Photocell 2 17 • GND
<b>PHOTOCELL 1</b>	First infrared sensor input in direction 1:	18 • 12V 19 • Photocell 1 20 • GND
<b>ACCESS CONTROL</b>	Right / left start input:	21 • 12V 22 • Left opening 23 • Right opening 24 • GND
<b>SPEAKER</b>	Without application	25 • + 26 • -
<b>BATTERY AND EXTERNAL POWER SUPPLY</b>	Power supply / batteries input:	27 • 12V (Battery) 28 • GND (Battery) 29 • GND (Power supply) 30 • 24V (Power supply)
<b>TURNSTILES CONNECTION</b>	Turnstile connection door:	31 • TA1 32 • TB1
<b>RS485</b>	RS485 output:	33 • TB2 34 • TA2
<b>SIDE LED</b>	Output for side LED:	35 • LED1 36 • COM 37 • LED2

<b>SIDE LED</b>	Output for side LED:	38 • LED3 39 • COM	40 • LED4
<b>DISPLAY LIGHT</b>	Indicator light output for input:	41 • GND 42 • Signal	43 • GND 44 • Signal
<b>COUNTING</b>	Without application	45 • 12V 46 • Signal	47 • GND 48 • Signal
<b>SOUND SIGNS</b>	Without application	49 • GND 50 • 12V	51 • GND 52 • 24V
<b>ENCODER</b>	Encoder connection:	53 • Black cable 54 • A 55 • B	56 • Z 57 • Red cable 58 • NC
<b>MOTOR</b>	Motor connection:	59 • Thin black cable 60 • HA 61 • HB 62 • HC	63 • Thin red cable 64 • W 65 • V 66 • U

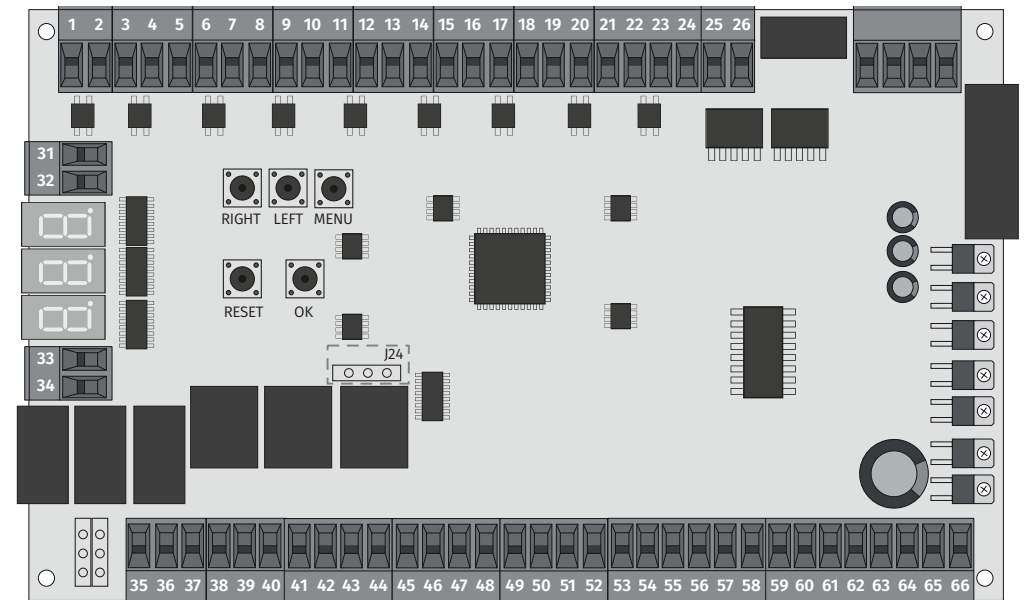



# 05. PROGRAMMING

## PRE-PROGRAMMING



Before connecting the turnstile, check the following items:

1. Power is supplied by a 24Vdc 10A power supply.
2. If the polarity and the sequence of all external connections (power, motor, etc.) are correct and all cables are well connected.

After connecting to the power, the motor automatically checks the left and right sides. The direction of the initial self-test will be the direction defined as input.

After the self-test is completed, the turnstile will remain in the middle position.

**If the movement of the door is interrupted, it may be fixation or connection errors. Contact the engine supplier.**

## NAVIGATING THE MENUS

All programming is configured as follows:

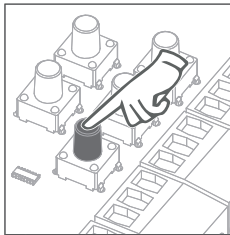

**01** • Press **MENU** for a few seconds to enter the programming.

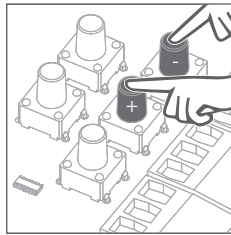

**02** • Navigate the functions using **+/-** and click **MENU** to enter the desired function.

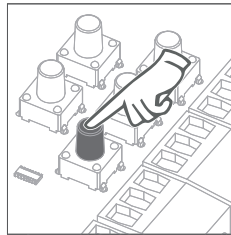

**03** • Adjust the function values using **+/-**.

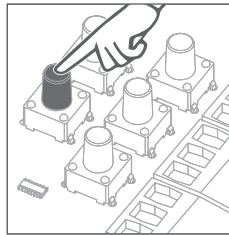

**04** • After the values are set, press **OK** to exit.

The following values will be displayed on the digital screen in the respective order of tasks:

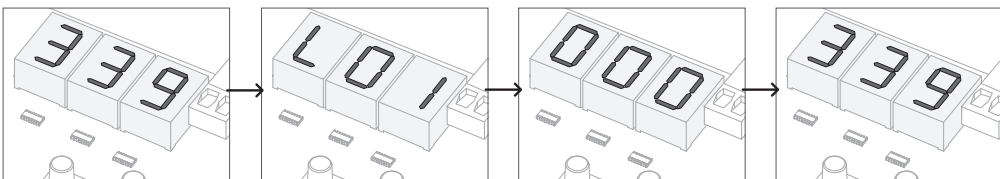

# 05. PROGRAMMING

## FUNCTIONS

### L01 MOTOR'S OPERATION MODE

It allows configuring the motor polarity.



**This function must be handled by specialized technicians!**

FACTORY VALUE
000

000	Negative switching of the main motor.
001	Positive switching of the main motor.
002	Positive switching of the secondary motor.
003	Negative switching of the secondary motor.
004	Negative switching of the magnetic brake of the main motor.
005	Positive switching of the magnetic brake of the main motor.
006	Positive switching of the secondary motor's magnetic braking.
007	Negative switching of the secondary motor's magnetic braking.

### L02 ENGINE OPERATION MODE

It allows the configuration of the motor.



**This function must be handled by specialized technicians!**

FACTORY VALUE
000

000	Brushless and encoder-free motor (main)
001	Brushless and encoder-free motor (secondary)
002	Brushless motor with encoder (main)
003	Brushless motor with encoder (secondary)
004	Motor with brush and encoder (main)
005	Motor with brush and encoder (secondary)
006	Magnetic braking mode

### L03 LEFT DOOR ANGLE ADJUSTMENT

It allows to adjust the position of the left door when it is in the closed position.

- The higher the value, the more closed the door angle will be.
- Value 30 = Intermediate Position**

FACTORY VALUE	MINIMUM VALUE	MAXIMUM VALUE
030	001	255

### L04 RIGHT DOOR ANGLE ADJUSTMENT

It allows to adjust the position of the right door when it is in the closed position.

- The higher the value, the more closed the door angle will be.
- Value 30 = Intermediate Position**

FACTORY VALUE	MINIMUM VALUE	MAXIMUM VALUE
030	001	255

## 05. PROGRAMMING

### FUNCTIONS

#### L05 OPENING SPEED

Allows you to adjust the opening speed of the door.  
 • *The higher the value, the higher the speed, the lower the value, the lower the opening speed of the door.*

FACTORY VALUE	MINIMUM VALUE	MAXIMUM VALUE
065	020	095

#### L06 CLOSING SPEED

Allows you to adjust the closing speed of the door.  
 • *The higher the value, the higher the speed, the lower the value, the lower the closing speed of the door.*

FACTORY VALUE	MINIMUM VALUE	MAXIMUM VALUE
065	020	095

#### L07 DECELERATION

It allows to adjust the deceleration value for the opening course and the closing course.  
 • *The higher the value, the sooner the course will begin to decelerate.*

FACTORY VALUE	MINIMUM VALUE	MAXIMUM VALUE
040	000	090

#### L08 "IN-POSITION" TIME SETTING

It allows to define the door travel speed in the opening / closing and closing / opening movement.  
 • *The higher the value, the higher the travel speed, the lower the value, the lower the travel speed.*

FACTORY VALUE	MINIMUM VALUE	MAXIMUM VALUE
003	001	040

#### L09 ANTI-CRUSHING RESPONSE TIME

It allows to adjust the response time of the "Anti-crush" system.

FACTORY VALUE	MINIMUM VALUE	MAXIMUM VALUE
005	001	040

## 05. PROGRAMMING

### FUNCTIONS

#### L10 ANTI-CRUSHING SENSITIVITY

It allows to adjust the sensitivity value of the "Anti-crush" system.  
 • *The higher the value, the greater the "Anti-crush" sensitivity.*

FACTORY VALUE	MINIMUM VALUE	MAXIMUM VALUE
010	000	090

#### L11 AUTOMATIC CLOSING TIME

It allows defining the seconds that the turnstile remains open from the moment the opening impulse is given, if there is no passage through the photocells.  
 • *When the set time is reached, the tourniquet closes automatically.*

FACTORY VALUE	MINIMUM VALUE	MAXIMUM VALUE
006	000	090

#### L12 TIME UNTIL CLOSURE AFTER PASSING

It allows to define the seconds that the turnstile remains open from the moment the photocells detect a passage.  
 • *When the set time is reached, the turnstile closes automatically.*  
**Value 1 = 0.1 seconds**

FACTORY VALUE	MINIMUM VALUE	MAXIMUM VALUE
000	000c	255

#### L13 OPERATING MODE

It allows to configure the operation mode of the turnstile.

FACTORY VALUE	NORMAL TRAFFIC MODE	TEST MODE
000	000	001

#### L14 ACTIVATION MODE





It allows configuring the activation mode for the passage through the turnstile.

FACTORY VALUE	ENTRY: CARD EXIT: CARD	ENTRY: FREE EXIT: CARD	ENTRY: CARD EXIT: FREE	FREE ACCESS
000	000	001	002	003

## 05. PROGRAMMING

### FUNCTIONS

L 15 MEMORY			
 <b>FUNCTION NOT APPLICABLE</b>	FACTORY VALUE	DO NOT MEMORIZE	TO MEMORIZE
	-	-	-

L 16 INFRARED RADIUS			
Allows you to select the polarity of the infrared ray.	FACTORY VALUE	NPN	PNP
	000	000	001
 <b>This function must be handled by specialized technicians!</b>			

L 17 PHOTOCELL MODE			
Allows you to select the amount of infrared used by the photocells.	FACTORY VALUE	6 INFRARED	6 INFRARED
	000	000	001
 <b>This function must be handled by specialized technicians!</b>			

L 18 SPEAKER			
 <b>FUNCTION NOT APPLICABLE</b>	FACTORY VALUE	ENTRY	EXIT
	-	-	-

L 19 ELECTROMAGNETIC LOCK			
 <b>FUNCTION NOT APPLICABLE</b>	FACTORY VALUE	NO LOCK	WITH LOCK
	-	-	-

## 06. MAINTENANCE

### MAINTENANCE



To make the maintenance of the turnstile, ensure that it is disconnected from the power supply.

- All external components of the turnstile (barriers, legs and structure) must be cleaned regularly to ensure proper functioning.
- Acidic or basic chemicals should not be used on the turnstile sheet surface.
- All sheet metal surfaces must be cleaned with a stainless maintenance spray. If you do not have a spray with the characteristics indicated, contact your supplier for advice.
- The mechanism must be cleaned and lubricated periodically every six months. For this purpose, suitable lubricating grease must be used.
- The damper and brake settings of the mechanism must be checked and adjusted during maintenance.
- The interior must be cleaned regularly with a dry cloth and must not be exposed to dust.

## 07. TROUBLESHOOTING

### INSTRUCTIONS FOR FINAL CONSUMERS / SPECIALIZED TECHNICIANS

Anomaly	Cause	Procedure
The motor does not brake, the LEDs are not running and the turnstile does not receive commands, even if there is power.	<ul style="list-style-type: none"> <li>• 230 Vac power may not be enough.</li> <li>• The control board's power cable may be disconnected.</li> <li>• The power supply may be defective.</li> </ul>	<ul style="list-style-type: none"> <li>• The power of the power supply must be checked with a multimeter.</li> <li>• Check all external and internal power cables physically for defects. Turn off the power to the cables before handling them.</li> </ul>
There is power in the turnstile, the LEDs are on, but the engine does not brake.	<ul style="list-style-type: none"> <li>• The motor cables may have been disconnected.</li> <li>• The access card may be defective.</li> </ul>	<ul style="list-style-type: none"> <li>• Check the connections between the control board and the motor.</li> <li>• Measure the voltage values.</li> </ul>
The LED lights are in the "green arrow" position, but the acrylic door does not allow passage.	<ul style="list-style-type: none"> <li>• The motor may be defective.</li> <li>• The access card may be defective.</li> </ul>	<ul style="list-style-type: none"> <li>• Check connections and the motor.</li> <li>• If the access card is defective, it must be replaced.</li> </ul>
The turnstile allows passage but does not close after passage. It closes automatically after several passes.	<ul style="list-style-type: none"> <li>• Directional sensors may be defective.</li> <li>• There may be a bad contact in the connection of the directional sensors.</li> <li>• The access card may be defective.</li> </ul>	<ul style="list-style-type: none"> <li>• If the sensors are defective, they must be replaced.</li> <li>• Check the cable terminals manually. If they are defective, they must be replaced.</li> <li>• If the access card is defective, it must be replaced.</li> </ul>
The turnstile works correctly with all its functions, but the LEDs do not light.	<ul style="list-style-type: none"> <li>• LED boards or cables may be defective.</li> <li>• The control board may be defective.</li> </ul>	<ul style="list-style-type: none"> <li>• If the LED board is defective, it must be replaced.</li> <li>• The LED cable must be checked.</li> </ul>